



**HIKVISION**

# **DS-K1108 Series Card Reader**

## **User Manual**

UD05868B

## **User Manual**

COPYRIGHT ©2017 Hangzhou Hikvision Digital Technology Co., Ltd.  
ALL RIGHTS RESERVED.

Any and all information, including, among others, wordings, pictures, graphs are the properties of Hangzhou Hikvision Digital Technology Co., Ltd. or its subsidiaries (hereinafter referred to be “Hikvision”). This user manual (hereinafter referred to be “the Manual”) cannot be reproduced, changed, translated, or distributed, partially or wholly, by any means, without the prior written permission of Hikvision. Unless otherwise stipulated, Hikvision does not make any warranties, guarantees or representations, express or implied, regarding to the Manual.

### **About this Manual**

This Manual is applicable to DS-K1108 series card reader

The Manual includes instructions for using and managing the product. Pictures, charts, images and all other information hereinafter are for description and explanation only. The information contained in the Manual is subject to change, without notice, due to firmware updates or other reasons. Please find the latest version in the company website (<http://overseas.hikvision.com/en/>).

Please use this user manual under the guidance of professionals.

Trademarks Acknowledgement

and other Hikvision’s trademarks and logos are the properties of Hikvision in various jurisdictions. Other trademarks and logos mentioned below are the properties of their respective owners.

Legal Disclaimer

TO THE MAXIMUM EXTENT PERMITTED BY APPLICABLE LAW, THE PRODUCT DESCRIBED, WITH ITS HARDWARE, SOFTWARE AND FIRMWARE, IS PROVIDED “AS IS”, WITH ALL FAULTS AND ERRORS, AND HIKVISION MAKES NO WARRANTIES, EXPRESS OR IMPLIED, INCLUDING WITHOUT LIMITATION, MERCHANTABILITY, SATISFACTORY QUALITY, FITNESS FOR A PARTICULAR

PURPOSE, AND NON-INFRINGEMENT OF THIRD PARTY. IN NO EVENT WILL HIKVISION, ITS DIRECTORS, OFFICERS, EMPLOYEES, OR AGENTS BE LIABLE TO YOU FOR ANY SPECIAL, CONSEQUENTIAL, INCIDENTAL, OR INDIRECT DAMAGES, INCLUDING, AMONG OTHERS, DAMAGES FOR LOSS OF BUSINESS PROFITS, BUSINESS INTERRUPTION, OR LOSS OF DATA OR DOCUMENTATION, IN CONNECTION WITH THE USE OF THIS PRODUCT, EVEN IF HIKVISION HAS BEEN ADVISED OF THE POSSIBILITY OF SUCH DAMAGES.

REGARDING TO THE PRODUCT WITH INTERNET ACCESS, THE USE OF PRODUCT SHALL BE WHOLLY AT YOUR OWN RISKS. HIKVISION SHALL NOT TAKE ANY RESPONSIBILITIES FOR ABNORMAL OPERATION, PRIVACY LEAKAGE OR OTHER DAMAGES RESULTING FROM CYBER ATTACK, HACKER ATTACK, VIRUS INSPECTION, OR OTHER INTERNET SECURITY RISKS; HOWEVER, HIKVISION WILL PROVIDE TIMELY TECHNICAL SUPPORT IF REQUIRED.

SURVEILLANCE LAWS VARY BY JURISDICTION. PLEASE CHECK ALL RELEVANT LAWS IN YOUR JURISDICTION BEFORE USING THIS PRODUCT IN ORDER TO ENSURE THAT YOUR USE CONFORMS THE APPLICABLE LAW. HIKVISION SHALL NOT BE LIABLE IN THE EVENT THAT THIS PRODUCT IS USED WITH ILLEGITIMATE PURPOSES.

IN THE EVENT OF ANY CONFLICTS BETWEEN THIS MANUAL AND THE APPLICABLE LAW, THE LATER PREVAILS.

0101011080229

# Chapter 1 Preventive and Cautionary Tips

To guarantee the card reader works properly, please read and obey the notes below.

- If the card reader is powered by the controller, the power supply distance is recommended to be no longer than 100m. If the distance is longer than 100m, you are advised to power the card reader by external 12V (range:  $-10\% \sim +10\%$ ) DC power supply, which is nonswitched and linear.
- To guarantee the communication between the controller and the card reader, you must use RVVP cable above 0.5 to connect them.
- If the card reader is installed outside or in environment easy to permeable, it is advisable to install a waterproof shield.
- If you need to install several card readers, the distance among them must over 30cm.
- To reduce the noise in long distance transmission, the shield of cable should connect to the GND of both controller and card reader terminal.

## Chapter 2 Introduction

DS-K1108 series card reader is a kind of high-performance product, with a 32 bit high-speed processor. It communicates with access controller via either RS-485 protocol (AES encrypted) or Wiegand protocol. And a build-in tamper-proof module helps to protect card reader from malicious damage. As to the physical appearance, the PC+ABS material makes water proof and dust proof possible in poor environment.

### 2.1 Front View

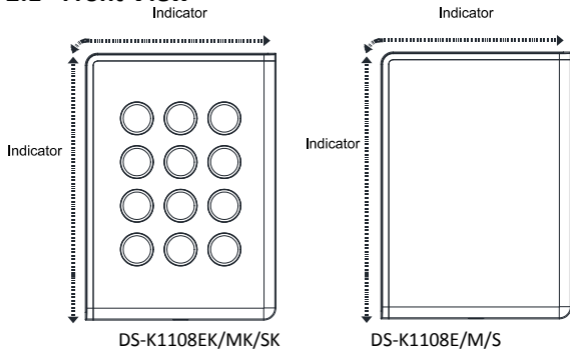

Figure 2-1 Front View of DS-K1108 Series

## 2.2 Rear View

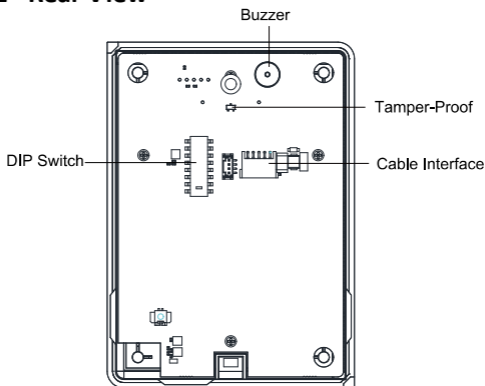

Figure 2-2 Rear View of DS-K1108 Series

## Chapter 3 Installation

### 3.1 Introduction for DIP Switch

The DIP switch module is shown below. The No. of DIP switch from left to right is 1 ~ 8.

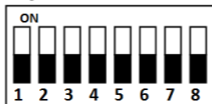



Figure 3-1 DIP Switch Module

Table 3-1 Description of DIP Switch

Icon	Description
	Represent 1 in binary mode
	Represent 0 in binary mode

For example, binary value of the following status is: 0000 1100.

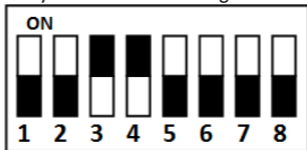

Figure 3-2 DIP Switch Module

Table 3-2 Description of DIP Switch

No.	Description	DIP Switch Status
1 ~ 4	Address of RS-485	1: 1 0: 0
5	Reserved	Reserved
6	Wiegand protocol or RS-485 protocol.	1: Wiegand protocol; 0: RS-485 protocol.
7	Wiegand Protocol (available when No. 6 is 1)	1: Wiegand protocol of 26-bit; 0: Wiegand protocol of 34-bit.
8	Matched Resistance (available for RS-485 protocol)	1: Enable; 0: Disable.

## 3.2 Definition of Cable

The description of 10 cables is shown below.

Table 3-3 Description of Cable

Color	Description
Orange	Wiegand ERR (available for Wiegand Protocol)
Brown	Wiegand OK (available for Wiegand Protocol)
White	Wiegand W1 (available for Wiegand Protocol)
Green	Wiegand W0 (available for Wiegand Protocol)
Blue	RS-485 -
Yellow	RS-485 +
Red	PWR (DC +12V)
Black	GND
Gray	TAMPER Control
Purple	Beep Control (available for Wiegand Protocol)

### 3.3 Wiring Cables

**Purpose:**

Wire the cables between controller and card reader, thus to establish the communication between them.

**Steps for RS-485 communication mode:**

1. Set the DIP switch of No. 6 as 0.
2. Set the DIP switch of No. 1 ~ 5 for RS-485 address and reading card mode. For details, please refer to 3.1 *Introduction for DIP Switch*.
3. Wire the cable between controller and card reader as shown below.



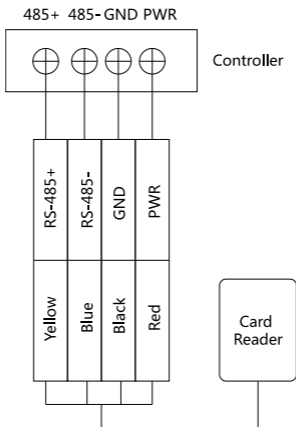

Figure 3-3 Wiring for RS-485 Communication Mode

**Steps for Wiegand communication mode:**

1. Set the DIP switch of No. 6 as 1.
2. Set the DIP switch of No. 5 and 7 for reading card mode and Wiegand protocol. For details, please refer to 3.1 *Introduction for DIP Switch*.
3. Wiring the cable between controller and card reader as shown below.

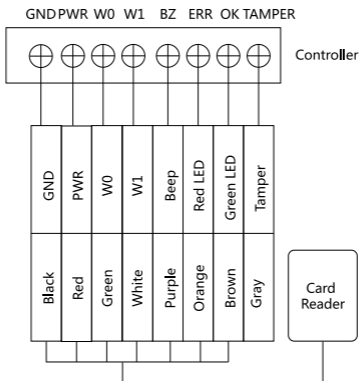

Figure 3-4 Wiring for Wiegand Communication Mode

## Chapter 4 Sound Prompt and Indicator

After the card reader is powered on, LED status indicator will turn green and blink for 1 time. Then it will turn red and blink for 3 times. At last the buzzer will send out a beep sound indicating the starting up process is completed.

During using the card reader, it will send out different sounds prompt and the LED indicator on it have different statuses. You can refer to tables below for detailed information.

Table 4-1 Description of Prompt Sound

Sound Prompt	Description
One beep	Swiping card prompt
	Pressing keys prompt
	Prompt for too long card No. input by pressing keys.
	Time out prompt for pressing keys or swiping card.
	For authentication: prompt for entering the password after swiping the card.
Two rapid beeps	The operation of pressing keys or swiping card is valid.
Three slow beeps	The operation of pressing keys or swiping card is invalid.
Rapidly continuous beeps	Prompt for tamper-proof alarm.
	Prompt for buzzer alarm.
Slowly continuous beeps	The card reader is unencrypted.

Table 4-2 Description of LED Indicator

LED Indicator Status	Description
Green (blink for 1 time), and red (blink for 3 times)	The card reader is power on.
Green and blinking	For Card + Password authentication: prompt for entering the password after swiping the card.
Solid green for 2s	The operation of pressing keys or swiping card is valid.
Solid red	Card reader is working normally.
Red and blink for 3 times	The operation of pressing keys or swiping card is invalid.
Red and blinking	For RS-485 protocol: Registering failed or card reader is offline.