

**HIKVISION**



# **Video Intercom Vandal-Resistant Door Station**

User Manual

*UD03854B*

### User Manual

©2017 Hangzhou Hikvision Digital Technology Co., Ltd.

This user manual is intended for users of the models below:

Series	Model
Vandal-Resistant Door Station	DS-KB8112-IM

It includes instructions on how to use the Product. The software embodied in the Product is governed by the user license agreement covering that product.

### **About this Manual**

This Manual is subject to domestic and international copyright protection. Hangzhou Hikvision Digital Technology Co., Ltd. (“Hikvision”) reserves all rights to this manual. This manual cannot be reproduced, changed, translated, or distributed, partially or wholly, by any means, without the prior written permission of Hikvision.

### **Trademarks**

***HIKVISION*** and other Hikvision marks are the property of Hikvision and are registered trademarks or the subject of applications for the same by Hikvision and/or its affiliates. Other trademarks mentioned in this manual are the properties of their respective owners. No right of license is given to use such trademarks without express permission.

### **Disclaimer**

TO THE MAXIMUM EXTENT PERMITTED BY APPLICABLE LAW, HIKVISION MAKES NO WARRANTIES, EXPRESS OR IMPLIED, INCLUDING WITHOUT LIMITATION THE IMPLIED WARRANTIES OF MERCHANTABILITY AND FITNESS FOR A PARTICULAR PURPOSE, REGARDING THIS MANUAL. HIKVISION DOES NOT WARRANT, GUARANTEE, OR MAKE ANY REPRESENTATIONS REGARDING THE USE OF THE MANUAL, OR THE CORRECTNESS, ACCURACY, OR RELIABILITY OF INFORMATION CONTAINED HEREIN. YOUR USE OF THIS MANUAL AND ANY RELIANCE ON THIS MANUAL SHALL BE WHOLLY AT YOUR OWN RISK AND RESPONSIBILITY.

TO THE MAXIMUM EXTENT PERMITTED BY APPLICABLE LAW, IN NO EVENT WILL HIKVISION, ITS DIRECTORS, OFFICERS, EMPLOYEES, OR AGENTS BE LIABLE TO YOU FOR ANY SPECIAL, CONSEQUENTIAL, INCIDENTAL, OR INDIRECT DAMAGES, INCLUDING, AMONG OTHERS, DAMAGES FOR LOSS OF BUSINESS PROFITS, BUSINESS INTERRUPTION, SECURITY BREACHES, OR LOSS OF DATA OR DOCUMENTATION, IN CONNECTION WITH THE USE OF OR RELIANCE ON THIS MANUAL, EVEN IF HIKVISION HAS BEEN ADVISED OF THE POSSIBILITY OF SUCH DAMAGES.

SOME JURISDICTIONS DO NOT ALLOW THE EXCLUSION OR LIMITATION OF LIABILITY OR CERTAIN DAMAGES, SO SOME OR ALL OF THE ABOVE EXCLUSIONS OR LIMITATIONS MAY NOT APPLY TO YOU.

### **Support**

Should you have any questions, please do not hesitate to contact your local dealer.

## Regulatory Information

### FCC Information

Please take attention that changes or modification not expressly approved by the party responsible for compliance could void the user's authority to operate the equipment.

**FCC compliance:** This equipment has been tested and found to comply with the limits for a Class B digital device, pursuant to part 15 of the FCC Rules. These limits are designed to provide reasonable protection against harmful interference in a residential installation. This equipment generates, uses and can radiate radio frequency energy and, if not installed and used in accordance with the instructions, may cause harmful interference to radio communications. However, there is no guarantee that interference will not occur in a particular installation. If this equipment does cause harmful interference to radio or television reception, which can be determined by turning the equipment off and on, the user is encouraged to try to correct the interference by one or more of the following measures:

- Reorient or relocate the receiving antenna.
- Increase the separation between the equipment and receiver.
- Connect the equipment into an outlet on a circuit different from that to which the receiver is connected.
- Consult the dealer or an experienced radio/TV technician for help.

### FCC Conditions

This device complies with part 15 of the FCC Rules. Operation is subject to the following two conditions:

1. This device may not cause harmful interference.
2. This device must accept any interference received, including interference that may cause undesired operation.

### EU Conformity Statement



This product and - if applicable - the supplied accessories too are marked with "CE" and comply therefore with the applicable harmonized European standards listed under the EMC Directive 2014/30/EU, the RoHS Directive 2011/65/EU.



2012/19/EU (WEEE directive): Products marked with this symbol cannot be disposed of as unsorted municipal waste in the European Union. For proper recycling, return this product to your local supplier upon the purchase of equivalent new equipment, or dispose of it at designated collection points. For more information see: [www.recyclethis.info](http://www.recyclethis.info)



2006/66/EC (battery directive): This product contains a battery that cannot be disposed of as unsorted municipal waste in the European Union. See the product documentation for specific battery information. The battery is marked with this symbol, which may include lettering to indicate cadmium (Cd), lead (Pb), or mercury (Hg). For proper recycling, return the battery to your supplier or to a designated collection point. For more information see: [www.recyclethis.info](http://www.recyclethis.info)

### Industry Canada ICES-003 Compliance

This device meets the CAN ICES-3 (B)/NMB-3(B) standards requirements.



### Safety Instruction

These instructions are intended to ensure that user can use the product correctly to avoid danger or property loss.

The precaution measure is divided into **Warnings** and **Cautions**:

**Warnings:** Neglecting any of the warnings may cause serious injury or death.

**Cautions:** Neglecting any of the cautions may cause injury or equipment damage.

	
<b>Warnings</b> Follow these safeguards to prevent serious injury or death.	<b>Cautions</b> Follow these precautions to prevent potential injury or material damage.



#### Warnings

- All the electronic operation should be strictly compliance with the electrical safety regulations, fire prevention regulations and other related regulations in your local region.
- Please use the power adapter, which is provided by normal company. The power consumption cannot be less than the required value.
- Do not connect several devices to one power adapter as adapter overload may cause over-heat or fire hazard.
- Please make sure that the power has been disconnected before you wire, install or dismantle the device.
- When the product is installed on wall or ceiling, the device shall be firmly fixed.
- If smoke, odors or noise rise from the device, turn off the power at once and unplug the power cable, and then please contact the service center.
- If the product does not work properly, please contact your dealer or the nearest service center. Never attempt to disassemble the device yourself. (We shall not assume any responsibility for problems caused by unauthorized repair or maintenance.)



#### Cautions

- Do not drop the device or subject it to physical shock, and do not expose it to high electromagnetic radiation. Avoid the equipment installation on vibrations surface or places subject to shock (ignorance can cause equipment damage).
- Do not place the device in extremely hot (refer to the specification of the device for the detailed operating temperature), cold, dusty or damp locations, and do not expose it to high electromagnetic radiation.
- The device cover for indoor use shall be kept from rain and moisture.

- Exposing the equipment to direct sun light, low ventilation or heat source such as heater or radiator is forbidden (ignorance can cause fire danger).
- Do not aim the device at the sun or extra bright places. A blooming or smear may occur otherwise (which is not a malfunction however), and affecting the endurance of sensor at the same time.
- Please use the provided glove when open up the device cover, avoid direct contact with the device cover, because the acidic sweat of the fingers may erode the surface coating of the device cover.
- Please use a soft and dry cloth when clean inside and outside surfaces of the device cover, do not use alkaline detergents.
- Please keep all wrappers after unpack them for future use. In case of any failure occurred, you need to return the device to the factory with the original wrapper. Transportation without the original wrapper may result in damage on the device and lead to additional costs.
- Improper use or replacement of the battery may result in hazard of explosion. Replace with the same or equivalent type only. Dispose of used batteries according to the instructions provided by the battery manufacturer.

# Table of Contents

<b>1 Overview</b> .....	<b>1</b>
1.1 Introduction.....	1
1.2 Main Features.....	1
1.3 Typical Application.....	3
<b>2 Appearance</b> .....	<b>4</b>
<b>3 Terminals and Wiring</b> .....	<b>5</b>
3.1 Terminals and Interfaces Description.....	5
3.2 Wiring Description.....	5
3.2.1 Door Lock Wiring .....	5
3.2.2 Door Magnetic Wiring.....	6
3.2.3 Exit Button Wiring.....	6
3.2.4 Alarm Device Input Wiring.....	7
<b>4 Installation</b> .....	<b>8</b>
4.1 Wall Mounting Plate .....	8
4.2 Wall Mounting .....	8
<b>5 Activating Door Station</b> .....	<b>12</b>
5.1 Activation via Web Browser.....	12
5.2 Activation via Batch Configuration Tool.....	13
5.3 Activation via iVMS-4200 Client Software .....	14
<b>6 Local Operation</b> .....	<b>16</b>
<b>7 Remote Operation via Web Browser</b> .....	<b>17</b>
7.1 Access to the Door Station.....	17
7.2 Live View .....	18
7.2.1 Live View Page .....	18
7.2.2 Starting Live View .....	19
7.2.3 Recording and Capturing Pictures Manually .....	20
7.3 Door Station Configuration.....	20
7.3.1 Configuring Local Parameters.....	20
7.3.2 Configuring System Settings.....	21
7.3.3 Configuring Video Intercom Parameters.....	28
7.3.4 Configuring Network Settings .....	32
7.3.5 Configuring Video/Audio Settings.....	38
7.3.6 Configuring Image Parameters.....	39
7.3.7 Configuring Event Settings .....	41
<b>8 Remote Operation via Batch Configuration Tool</b> .....	<b>46</b>
8.1 Editing Network Parameters.....	46
8.2 Adding Device .....	47

8.2.1 Adding Online Device .....	47
8.2.2 Adding by IP Address .....	48
8.2.3 Adding by IP Segment .....	48
8.3 Configuring Devices Remotely .....	49
8.3.1 System .....	49
8.3.2 Video Intercom .....	54
8.3.3 Network .....	62
8.3.4 Video Display .....	67
8.4 Video Intercom Device Set-up Tool .....	69
8.4.1 Setting a Community Structure .....	70
8.4.2 Setting Main/Sub Door Station .....	70
8.5 Batch Upgrading .....	73
8.5.1 Adding Devices for Upgrading .....	73
8.5.2 Upgrading Devices .....	75
<b>9 Remote Operation via iVMS-4200 Client Software .....</b>	<b>77</b>
9.1 System Configuration .....	77
9.2 Device Management .....	78
9.2.1 Adding Video Intercom Devices .....	78
9.2.2 Modifying Network Information .....	81
9.2.3 Resetting Password .....	81
9.3 Configuring Devices Remotely via iVMS-4200 .....	83
9.4 Picture Storage .....	83
9.4.1 Adding Storage Server .....	84
9.4.2 Formatting the HDDs .....	85
9.4.3 Configuring Storage Server Picture Storage .....	85
9.5 Live View .....	87
9.6 Video Intercom Configuration .....	89
9.6.1 Group Management .....	90
9.6.2 Video Intercom .....	95
9.6.3 Notice Management .....	96
9.7 Device Arming Control .....	98
<b>Appendix .....</b>	<b>100</b>
Installation Notice .....	100
Wiring Cables .....	100



# 1 Overview

---

## 1.1 Introduction

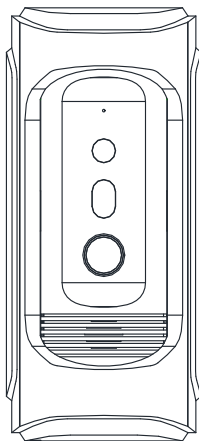

The DS-KB8112-IM is a vandal-resistant door station, which has passed IK 9 (Impact Protection Level). The door station, featuring in the vandal-resistant design, convenient installation, and easy operation, supports the video intercom function, access control function, door magnetic alarm, motion detection, and so on. As an intelligent device, the door station is mainly applied in the villa for improving the living security.

## 1.2 Main Features

### Basic Functions

- Video intercom function, supporting the communication with the master station, and the indoor station
- Access control function, supporting multiple door opening modes (the indoor station, the master station, the client software, and the web)
- Self-adaptive IR supplement with max. 5-meter IR distance
- High-performance embedded SOC processor
- IK 9 and IP 66

### Video/Audio Functions

- HD video surveillance with WDR wide angle and high performance CMOS, up to 720P @ 30 fps

- Noise suppression and echo cancellation
- H.264 video compression standard
- Low illumination

### **Alarm Functions**

- Supports door magnetic alarm
- Auto-uploads alarm messages to the master station or the client software

### **Remote Controls**

- Remote reboot, remote upgrade, time synchronization via NTP, and batch configuration function
- Supports Web remote access and OSD display
- Supports motion detection

### **Additional Features**

- ISAPI (Internet Server Application Programming Interface) and ONVIF (Open Network Video Interface Forum) supported, to ensure greater compatibility and interoperability among different platforms
- Supports bit rate and frame rate configuration, P/N video standard configuration, Email configuration, and auto day & night switch
- Auto-uploads captured pictures to the FTP or the client software while unlocking the door

### 1.3 Typical Application

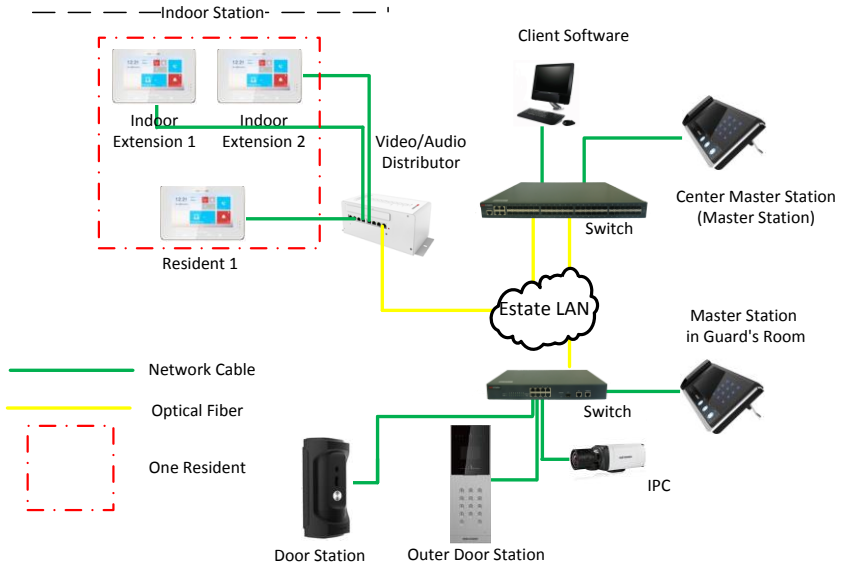

**Note:**

DS-KB8112-IM door station can work as a doorphone both in a villa or in an apartment.

## 2 Appearance

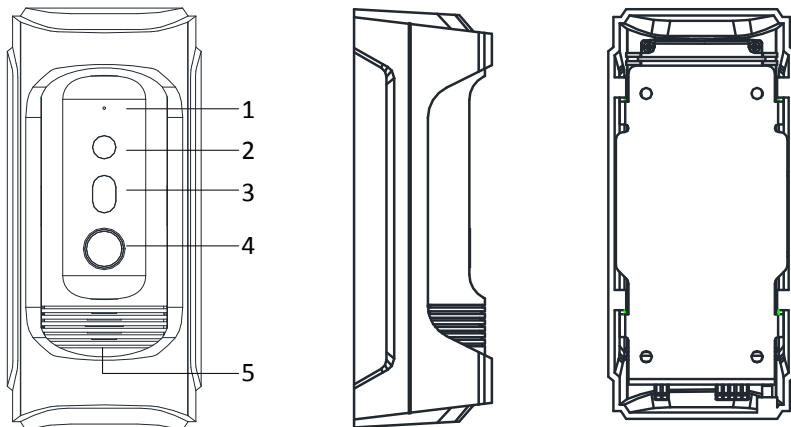

Figure 2-1 Door Station Overview

Table 2-1 Components Description

No.	Description
1	Microphone
2	Built-in Camera
3	Low Illumination Supplement Light
4	Call Button
5	Loudspeaker

**Note:**

- Default settings of call button: when you press the call button, it calls the resident; and when you hold down the call button, it calls the center.
- You can change the calling mode via Batch Configuration Tool or iVMS-4200 client software or the web browser. See 7.3.3 *Configuring Video Intercom Parameters* and 8.3.2 *Video Intercom* for detail steps.

## 3 Terminals and Wiring

### 3.1 Terminals and Interfaces Description

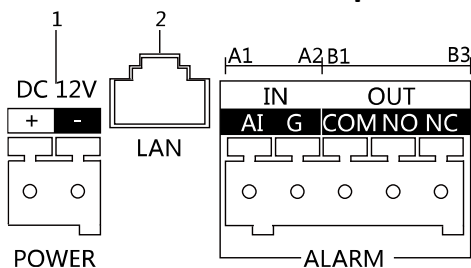

Figure 3-1 Terminals and Interfaces

Table 3-1 Terminals and Interfaces Description

Name	No.	Interfaces	Description
Power Supply	1	12 VDC	12 VDC Power Supply Input
LAN	2	LAN	Network Interface (PoE Supported)
ALARM IN	A1	AI	Alarm Input
	A2	GND	Grounding
ALARM OUT	B1	COM	Grounding Signal
	B2	NO	Door Lock Relay Output (Connect Electric Strike)
	B3	NC	Door Lock Relay Output (Connect Electric Bolt or Magnetic Lock)

### 3.2 Wiring Description

#### 3.2.1 Door Lock Wiring

Terminal NC/COM is set as default for connecting magnetic lock/electric bolt; terminal NO/ COM is set as default for connecting electric strike.

To connect electric lock, it is required to set the output of terminal NC/ COM/ NO to be electric lock with Batch Configuration Tool or iVMS-4200 client software or the web browser.

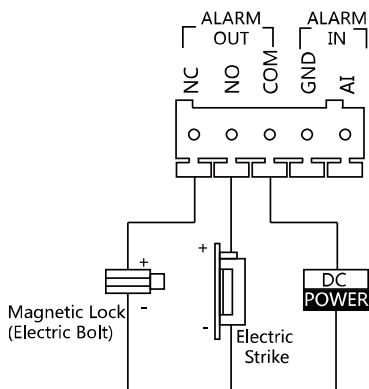

Figure 3-2 Door Lock Wiring

### 3.2.2 Door Magnetic Wiring

To connect door magnetic, it is required to set the output of terminal AI to be door status via Batch Configuration Tool or iVMS-4200 client software or the web browser.

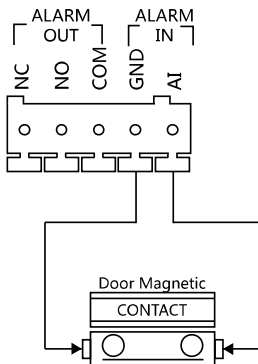

Figure 3-3 Door Magnetic Wiring

### 3.2.3 Exit Button Wiring

To connect exit button, it is required to set the output of terminal AI to be door status via Batch Configuration Tool or iVMS-4200 client software or the web browser.

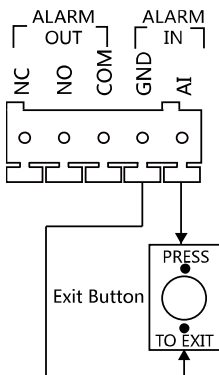

Figure 3-4 Exit Button Wiring

### 3.2.4 Alarm Device Input Wiring

When you set the output of terminal AI to be custom via Batch Configuration Tool or iVMS-4200 client software or the web browser, you can connect any alarm input device to the door station via the terminal AI.

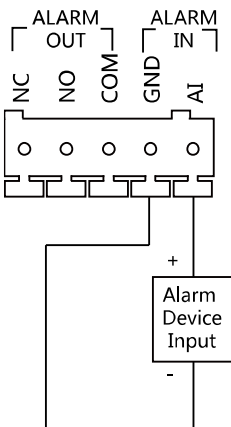

Figure 3-5 Alarm Device Input Wiring

## 4 Installation

### **Before you start:**

- Make sure the device in the package is in good condition and all the assembly parts are included.
- The device supports two ways of power supply: 12 VDC, or PoE power supply. Please make sure your power supply matches your door station.
- Make sure all the related equipment is power-off during the installation.
- Make sure the wall is strong enough to withstand 4 times the weight of the door station.
- Check the specification of the product for the installation environment.

### 4.1 Wall Mounting Plate

To install the door station onto the wall, you are required to use a matched mounting plate.

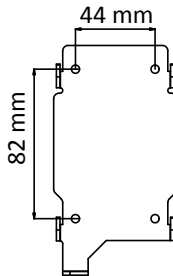

Figure 4-1 Wall Mounting Plate

**Note:** The dimensions above are theoretical. The actual size can be slightly different from the theoretical dimension.

### 4.2 Wall Mounting

#### **Steps:**

1. Fix the wall mounting plate to the wall with 4 expansion screws.



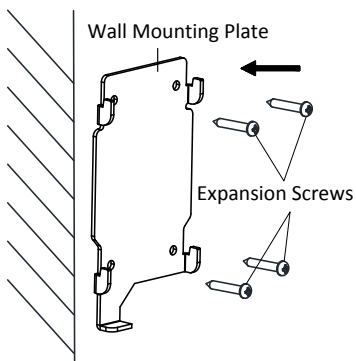

Figure 4-2 Install the Plate

2. Insert terminal blocks into the interfaces of the door station body, and connect the network cable.

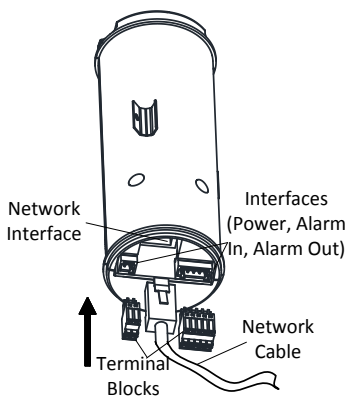

Figure 4-3 Insert Terminals and Network Cable

3. Fix the door station main body to the protective shield tightly.

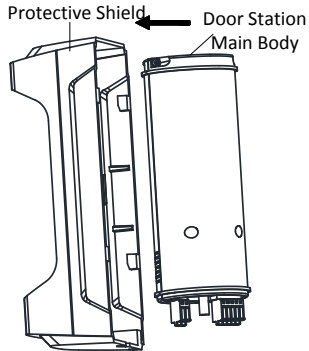

Figure 4-4 Fix the Main Body to the Shield

4. Hook the door station to the wall mounting plate tightly.

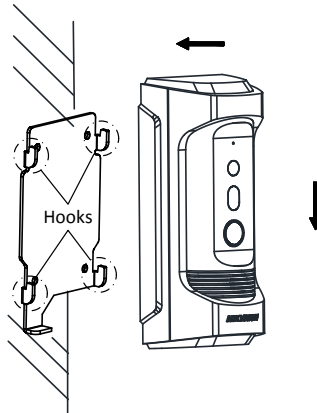

Figure 4-5 Hook the Door Station to the Plate

5. Use the set screw to secure the door station with the mounting plate.

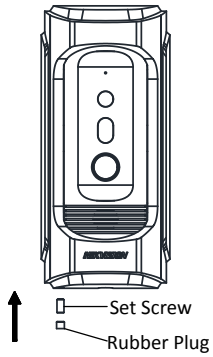

Figure 4-6 Secure the Door Station

## 5 Activating Door Station

### Purpose:

You are required to activate the device first by setting a strong password for it before you can use the device.

Activation via Batch Configuration Tool, Activation via Web Browser, and activation via iVMS-4200 client software are supported.

### 5.1 Activation via Web Browser

#### Steps:

1. Power on the device, and connect the device to the network.
2. Input the default IP address to the address bar of the web browser, and click **Enter** to the activation interface.

Figure 5-1 Activation Interface (Web)

3. Create a password, and confirm the password.



**STRONG PASSWORD RECOMMENDED**— We highly recommend you create a strong password of your own choosing (Using a minimum of 8 characters, including at least three of the following categories: upper case letters, lower case letters, numbers, and special characters.) in order to increase the security of your product. And we recommend you reset your password regularly, especially in the high security system, resetting the password monthly or weekly can better protect your product.

4. Click **OK** to activate the device.

**Note:** The device default IP address is 192.0.0.65.

## 5.2 Activation via Batch Configuration Tool

### Steps:

1. Run the Batch Configuration Tool.

Index	Device Type	IP Address	Port	Software Version	Serial No.	Security Status	Added
1	XX-XXXX-XX	10.16.2.77	8000	Vx.x.x build xxxxxx	XX-XXXXX-XXXXXXXXXXXXXXXXXXXXXXXXXXXX	Activated	Yes
2	XX-XXXX-XX	10.16.2.103	8000	Vx.x.x build xxxxxx	XX-XXXXX-XXXXXXXXXXXXXXXXXXXXXXXXXXXX	Activated	No
3	XX-XXXX-XX	10.16.2.114	8000	Vx.x.x build xxxxxx	XX-XXXXX-XXXXXXXXXXXXXXXXXXXXXXXXXXXX	Activated	No
4	XX-XXXX-XX	10.16.2.222	8000	Vx.x.x build xxxxxx	XX-XXXXX-XXXXXXXXXXXXXXXXXXXXXXXXXXXX	Activated	No
5	XX-XXXX-XX	192.0.0.65	8000	Vx.x.x build xxxxxx	XX-XXXXX-XXXXXXXXXXXXXXXXXXXXXXXXXXXX	Inactive	No

Figure 5-2 Select Inactive Device

2. Select an inactivated device and click **Activate**.

**Activate**

Password:

Valid password range [8-16].  
You can use a combination  
of numbers, lowercase,  
uppercase and special  
character for your password  
with at least two kinds of  
them contained.

Confirm Password:

Figure 5-3 Activation Interface (Batch Configuration Tool)

3. Create a password, and confirm the password.



**STRONG PASSWORD RECOMMENDED**— We highly recommend you create a strong password of your own choosing (Using a minimum of 8 characters, including at least three of the following categories: upper case letters, lower case letters, numbers, and special characters.) in order to increase the security of your product. And we recommend you reset your password regularly, especially in the high security system, resetting the password monthly or weekly can better protect your product.

4. Click **OK** to activate the device.

### Note:

- When the device is not activated, the basic operation and remote operation of device cannot be performed.

- You can hold the **Ctrl** or **Shift** key to select multiple devices in the online devices, and click **Activate** to activate devices in batch.

## 5.3 Activation via iVMS-4200 Client Software

### Steps:

1. Run the iVMS-4200 client software.

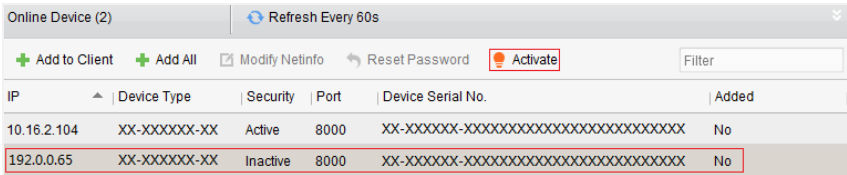

Figure 5-4 Select Inactive Device

2. Select an inactivated device and click **Activate**.

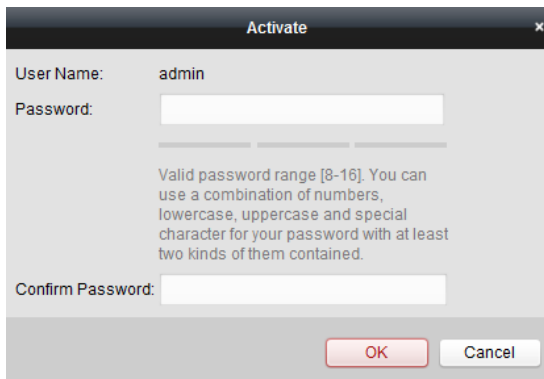

Figure 5-5 Activation Interface (iVMS-4200)

3. Create a password, and confirm the password.

**STRONG PASSWORD RECOMMENDED**— *We highly recommend you create a strong password of your own choosing (Using a minimum of 8 characters, including at least three of the following categories: upper case letters, lower case letters, numbers, and special characters.) in order to increase the security of your product. And we recommend you reset your password regularly, especially in the high security system, resetting the password monthly or weekly can better protect your product.*

4. Click **OK** to activate the device.

**Note:**

- When the device is not activated, the basic operation and remote operation of device cannot be performed.
- You can hold the **Ctrl** or **Shift** key to select multiple devices in the online devices, and click **Activate** to activate devices in batch.

## 6 Local Operation

### **Before you start:**

- Make sure the door station has been activated.
- Make sure the network cable is well-connected.

### **Purpose:**

You can call the resident (the indoor station) or the center (the master station) via the door station by pressing or holding the call button.

Default settings of the call button: when you press the call button, it calls the resident, and when you hold the call button, it calls the center.

### **Steps:**

1. Press the call button to call the resident.
2. The resident can accept/decline the calling from the door station, and unlock the door via the indoor station.

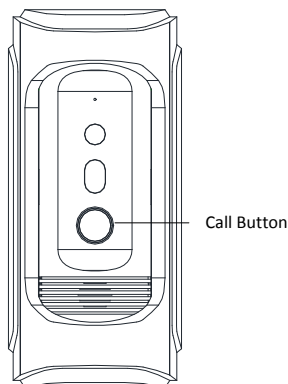

Figure 6-1 Call Button of Door Station

### **Notes:**

- Besides the indoor station, you can also unlock the door by the master station, the client software, and the web.
- When the video intercom between you and the resident is realized, you can speak to the resident, and the live view of door station will be displayed on the connected indoor station.
- When live view of door station is displayed on other devices or door station is calling resident, the door station will detect the brightness of video. When the brightness is lower than the expected threshold, the supplement light will be enabled.
- When the supplement light is enabled, the backlight of key will be auto-enabled, otherwise, the door station will detect the brightness of live view and enable the backlight of key when the brightness of live view is lower than expected threshold.



## 7 Remote Operation via Web Browser

### 7.1 Access to the Door Station

#### **System Requirement:**

Operating System: Microsoft Windows XP SP1 and above version

CPU: 2.0 GHz or higher

RAM: 1G or higher

Display: 1024×768 resolution or higher

Web Browser: 32-bit Internet Explorer 8.0 to 11

#### **Steps:**

1. Open the web browser.
2. Input the IP address of the door station in the address bar, and press the **Enter** key to enter the login interface.
3. Input the user name and password and click **Login**.

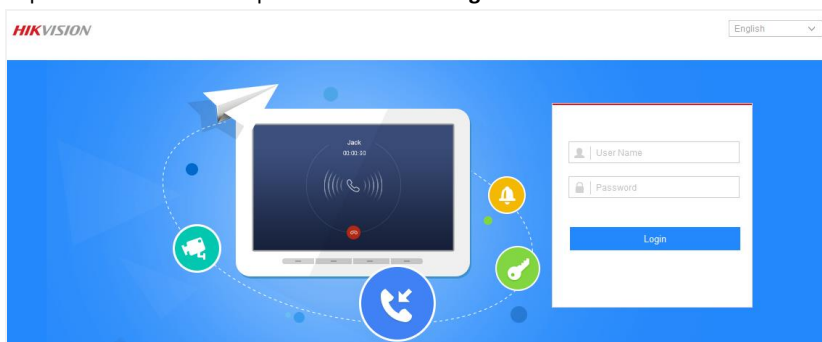
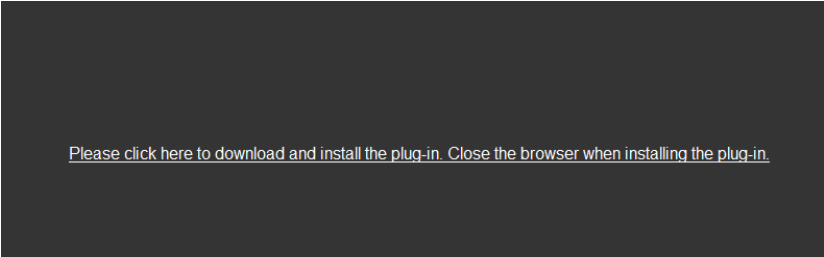

Figure 7-1 Login Interface

**Note:** Switch the display language from the upper-right corner among different languages.

4. Install the plug-in before viewing the live video and operating the door station. Please follow the installation prompts to install the plug-in.



[Please click here to download and install the plug-in. Close the browser when installing the plug-in.](#)

Figure 7-2 Download and Install Plug-in

**Note:**

- You may have to close the web browser to install the plug-in. Please reopen the web browser and log in again after installing the plug-in.
- If the device is not activated, please activate the device first.
- The device IP address gets locked if the admin user performs 7 failed password attempts.

## 7.2 Live View

### 7.2.1 Live View Page

**Purpose:**

The live view page allows you to view the real-time video, capture images, unlock the door, and configure video parameters.

Log in the door station to enter the live view page, or you can click **Live View** on the menu bar of the main page to enter the live view page.

**Note:** You can also access to the door station to get the live view in different live view modes via iVMS-4200 client software.

## Descriptions of the live view page:

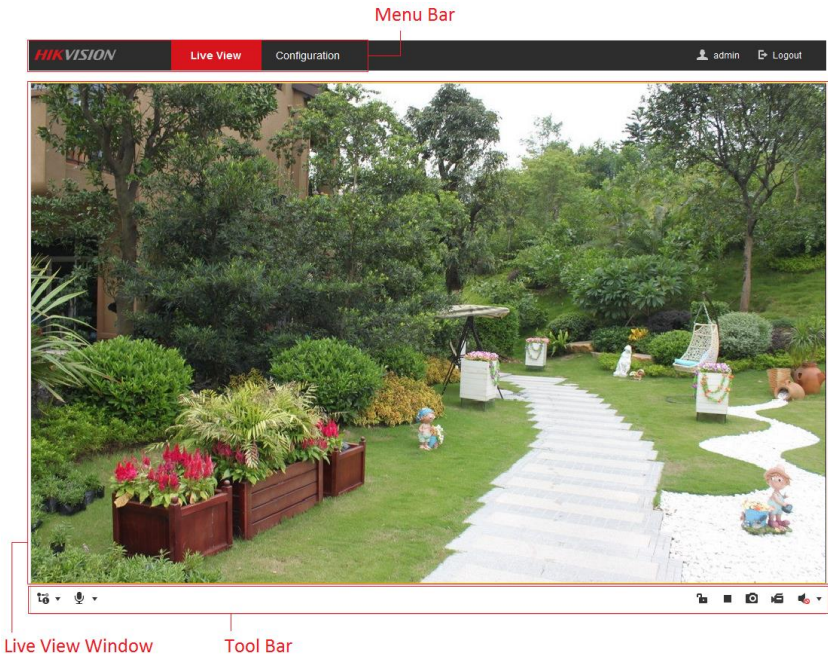

Figure 7-3 Live View Page

### Menu Bar:

Click the tab to enter Live View, and Configuration page respectively.

### Live View Window:

Display the live video on the display window of live view.

### Toolbar:











Set the stream type, enable/disable the two-way audio, unlock the door, start/stop the live view, capture pictures, record the video files, and adjust the audio volumes.

**Note:** After stopping the live view, only stream switch, two-way audio settings, door unlocking settings are supported.

## 7.2.2 Starting Live View



Click **Live View** on the menu bar or click the icon ▶ to start the live view.

Table 7-1 Descriptions of Live View Icons

Icon	Description
	Set the stream type as main stream  or sub stream  .
	Enable/disable the two-way audio.
	Unlock the door.
	Start/stop the live view.
	Capture pictures manually.
	Start/stop recording.
	Audio on and adjust the audio volume.
	Mute

**Note:** After stopping the live view, only stream switch, two-way audio settings, and door unlocking settings are supported.

### 7.2.3 Recording and Capturing Pictures Manually

In the live view page, click  on the tool bar to capture the live pictures, and click  to record the live video. The saving paths of the captured pictures and record files can be set on the **Configuration > Local** page, and please refer to 7.3.1 *Configuring Local Parameters* for detailed instructions.

**Note:** The captured picture will be saved as JPEG file or BMP file in the local PC that runs the web browser.

## 7.3 Door Station Configuration

### 7.3.1 Configuring Local Parameters

**Purpose:**

Local configuration provides image file settings and record file settings. The recorded videos and captured pictures can be saved on the local PC that runs the web browser.

**Steps:**

1. Enter the Local Configuration interface: **Configuration > Local**.

**Image File**

Image Format  JPEG  BMP

Save snapshots in live view to

---

**Record File Settings**

Record File Size  256M  512M  1G

Save record files to

Figure 7-4 Local Configuration

2. Configure the image file settings and the record file settings.

**Image File Settings:** Set the saving path of the captured pictures. It is valid for the captured pictures you captured with the web browser.

- **Image Format:** Set the saving format for the captured pictures. The captured pictures can be saved in format of \*.jpeg or \*.bmp.
- **Save snapshots in live view to:** Set the saving path of the manually captured pictures in live view mode.

**Record File Settings:** Set the saving path of the recorded video files. It is valid for the record files you recorded with the web browser.

- **Record File Size:** Select the packed size of the manually recorded and downloaded video files to 256M, 512M, or 1G. After the selection, the maximum record file size is the value you selected.
- **Save record file to:** Set the saving path for for the manually recorded video files.

**Note:** You can click **Browser** to change the directory for saving the pictures and record files. And click **Open** to open the set folder.

3. Click **Save** to save the settings.

### 7.3.2 Configuring System Settings

#### Viewing Basic Information

Enter the Basic Information interface: **Configuration > System > System Settings > Basic Information**.

In the Basic Information interface, you can edit the device name, and the device No..

Other information of the door station, such as model, serial No., firmware version, encoding version, web version, and plugin version, are displayed. The information cannot be changed in this menu. It is the reference for maintenance or modification in future.

Basic Information	Time Settings	DST
Device Name	Embedded Net VIS	
Device No.	255	
Model	XX-XXXXXX-XX	
Serial No.	XX-XXXXXX-XXXXXXXXXXXXXXXXXXXXXXXXXXXX	
Firmware Version	Vx.x.x build xxxxxx	
Encoding Version	Vx.x build xxxxxx	
Web Version	Vx.x.x build xxxxxx	
Plugin Version	Vx.x.x.x	
 Save		

Figure 7-5 Device Basic Information

## Time and DST Settings

### **Purpose:**

You can follow the instructions in this section to configure the time synchronization and DST settings.

- **Time Settings**

### **Steps:**

1. Enter the Time Settings interface: **Configuration > System > System Settings > Time Settings.**

Basic Information
Time Settings
DST

Time Zone (GMT+08:00) Beijing, Urumqi, Singapore ▾

**NTP**

NTP

Server Address

NTP Port

Interval  min

**Manual Time Sync.**

Manual Time Sync.

Device Time

Set Time   Sync. with computer time

Save

Figure 7-6 Time Settings

2. Select the time zone of your location from the drop-down list.
3. Synchronize the time.
  - **Synchronizing Time by NTP Server**
    - 1) Check the **NTP** item to enable the NTP function.
    - 2) Configure the following settings:
      - Server Address:** IP address of NTP server.
      - NTP Port:** Port of NTP server. The default NTP port No. is 123.
      - Interval:** The time interval between the two synchronizing actions with NTP server.
  - **Synchronizing Time Manually**
    - 1) Check the **Manual Time Sync.** item to enable the manual time synchronization function.
    - 2) Click the icon to open the calendar page.
    - 3) Click on the calendar to select the date, set the time, and click **OK** to save.

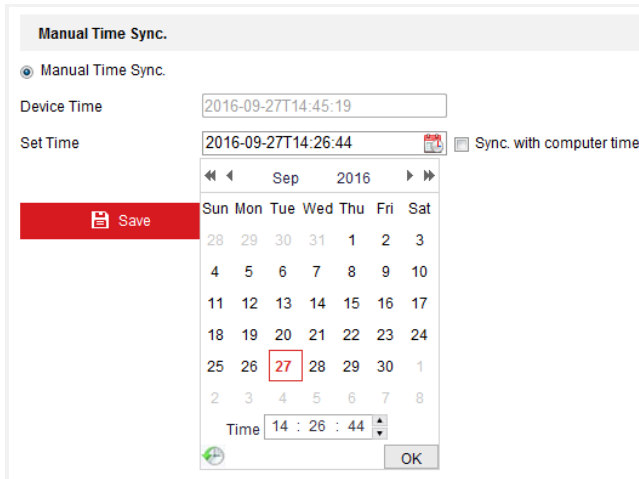

Figure 7-7 Time Sync. Manually

4) (Optional) You can check the checkbox of **Sync. with computer time** to synchronize the time of the device with that of the local PC that runs the web browser.

4. Click **Save** to save the settings.

● **DST**

**Purpose:**

For regions using the summer time, DST (daylight saving time) settings can be configured according to the actual needs.

**Steps:**

1. Enter the DST settings interface: **Configuration > System > System Settings > DST.**
2. Check the checkbox of **Enable DST** to enable the daylight saving time.
3. Set the start time and the end time for the DST period.
4. Select the DST bias from the drop-down list.
5. Click **Save** to save the settings.



Basic Information   Time Settings   **DST**

Enable DST

Start Time   Apr.   First   Sun.   02

End Time   Oct.   Last   Sun.   02

DST Bias   30min

Save

Figure 7-8 DST Settings

## Upgrade and Maintenance

### Purpose:

On Upgrade & Maintenance interface, you can reboot the door station, restore door station parameters, export/import configuration parameters, and upgrade firmware.

Enter the Upgrade and Maintenance interface:

**Configuration > System > Maintenance > Upgrade & Maintenance**

Upgrade & Maintenance   Log

**Reboot**

Reboot the device.

**Default**

Reset all the parameters, except the IP parameters and user information, to the default settings.

Restore all parameters to the default settings.

**Export**

**Import parameters**

Device Parameters  

Status

**Upgrade**

Upgrading File  

Status

Note: It will take 1 to 10 minutes for the upgrading process. Do not power off the device during the upgrading process. The device will reboot automatically after upgrading.

Figure 7-9 Upgrade and Maintenance

- **Rebooting Door Station**  
Click **Reboot** to reboot the door station.
- **Restoring Settings**  
Click **Restore** to restore the default parameters.

Click **Restore All** to restore all parameters of device and reset the device to inactive status.

**Note:**

- By clicking **Restore**, all default settings, excluding network parameters and user information, will be restored.
- By clicking **Restore All**, all default settings, including network parameters and user information, will be restored. The device will be reset to inactivated status.
- **Exporting/Importing Configuration File**

**Purpose:**

Configuration file is used for the batch configuration of the door station, which can simplify the configuration steps when there are a lot of door stations needing configuring.

**Steps:**

1. Click **Export** to export the current configuration file, and save it to the certain place.
2. Click **Browse** to select the saved configuration file and then click **Import** to start importing configuration file.

**Note:** You need to reboot the door station after importing configuration file.

- **Upgrading the System**

Click **Browse** to select the local upgrade file and then click **Upgrade** to start remote upgrade.

**Note:** The upgrading process will take 1 to 10 minutes. Do not power off the door station during the process. The door station will reboot automatically after upgrading.

## Log Searching

**Purpose:**

The operation, alarm, exception and information of the door station are stored in log files.

**Steps:**

1. Enter the log searching interface: **Configuration > System > Maintenance > Log.**

The screenshot shows the 'Log' page under 'Upgrade & Maintenance'. It features search filters for Major Type, Minor Type, Start Time, and End Time, along with a Search button. Below the filters is a table titled 'Log List' with columns for No., Time, Major Type, Minor Type, Local/Remote User, Remote Host IP, and Details.

Log List						
No.	Time	Major Type	Minor Type	Local/Remote User	Remote Host IP	Details

Figure 7-10 Log Searching Interface

2. Set the log search conditions to specify the search, including the major type, minor type, start time and end time.
3. Click **Search** to search log files. The matched log files will be displayed on the **Log** interface.

## User Management

### Steps:

1. Enter the User Management interface: **Configuration > System > User Management**.

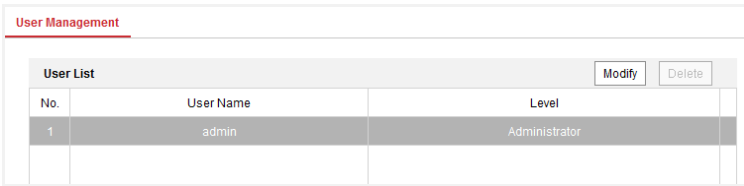

Figure 7-11 User Management Interface

2. Click the user and click **Modify**.
3. Edit the password.
4. Click **OK** to finish the user modification.

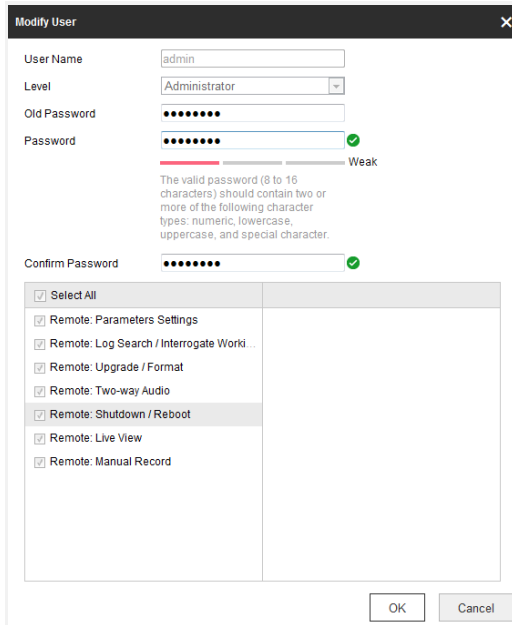

Figure 7-12 Modify a User

**Note:** Only password can be changed.

### 7.3.3 Configuring Video Intercom Parameters

#### Door Station No.

**Purpose:**

To call the door station via the client software or to call indoor stations/the client software/the master station via the door station successfully, you should number the door station first. You should set the community No., the building No., the unit No., and the floor No. for the door station.

The door station supports 2 device types: villa door station and doorphone. When it works as a doorphone, there is no need setting the community No., the building No., the unit No., the floor No. or the device No..

**Steps:**

1. Enter the device No. settings interface: **Configuration > Video Intercom > Device No. Settings.**

Device No. Settings	
Device Type	Villa Door Station
Community No.	1
Building No.	1
Unit No.	1
Floor No.	1
Device No.	0

Save

Figure 7-13 Set the Device No.

2. Select the device type from the drop-down list: Villa Door Station or Doorphone.
3. Set the the community No., the building No., the unit No., and the floor No..

**Note:**

- When you set 1, 2, 3, and 4 to the community No., the building No., the unit No., and the floor No. respectively, the No. of the door station can be written as 1-2-3-4.
- When you set the device type as doorphone, there is no need setting the community No., the building No., the unit No., or the floor No..

4. Set the device No..

**Note:**

- The device No. requires configuring when the device type of the door station is **Villa Door Station.**

- If the device No. is set to 0, the door station works as the main door station.
- If the device No. is larger than 0, the door station works as the sub door station. The device No. can range from 1 to 99.
- At least one main door station should be configured for each villa or building.
- You can customize up to 8 sub door stations for each main door station.

5. Click **Save** to finish the door station No. settings.

### Operation Time

#### **Purpose:**

You can set the maximum speaking duration between the door station and other video intercom devices, and the maximum message duration of the door station on the operation time settings interface.

#### **Steps:**

1. Enter the operation time settings interface: **Configuration > Video Intercom > Operation Time Settings.**

Operation Time Settings		
Device Type	<input type="text" value="Villa Door Station"/>	
Max. Message Duration	<input type="text" value="30"/>	Second ✓
Max. Speaking Duration	<input type="text" value="90"/>	Second ✓
<input type="button" value="Save"/>		

Figure 7-14 Set the Operation Time

2. Set the Max. message duration and the Max. speaking duration.
3. Click **Save** to finish the operation time settings.

#### **Note:**

- The maximum message time varies from 30s to 60s.
- The maximum speaking duration varies from 90s to 120s.

### Access Control Parameters

#### **Purpose:**

On the access control settings interface, you can set the door No., and the door-unlocked duration.

If you set the door-unlocked duration, the door will be locked automatically beyond the set duration once the door is open.

#### **Steps:**

1. Enter the access control settings interface: **Configuration > Video Intercom > Access Control.**

Figure 7-15 Set the Access Control Parameters

2. Set the door No., and the door-unlocked duration.

**Note:**

- The door-unlocked duration varies from 1s to 255s.
- The door station, instead of the doorphone, supports configuring the access control parameters.

**I/O Input/Output**

**Purpose:**

I/O input/output refers to the Alarm In terminal and the Alarm Out terminal. You can connect external devices to the door station via these terminals. The door station has 1 Alarm In terminal (AI), and 1 Alarm Out terminal (NO/COM/NC).

**Steps:**

1. Enter the IO input/output settings interface: **Configuration > Video Intercom > IO Input/Output.**

Figure 7-16 Set the IO Input/Output

2. Set the input mode: Disabled, Exit Button, Door Status, Custom.

**Disabled:** The function of the AI terminal is disabled.

**Exit Button:** The AI terminal supports connecting to the exit button.

**Door Status:** The AI terminal supports connecting to the door magnetic.

**Custom:** It is reserved.

3. Set the output mode: Disabled, Electric Lock, Custom.

**Disabled:** The function of the NO/NC/COM terminal is disabled.

**Electric Lock:** The NO/NC/COM terminal supports connecting to the electric lock (electric strike, and magnetic lock).

**Custom:** It is reserved.

4. Click **Save** to finish the settings.

### Call Button

#### **Purpose:**

You can call the indoor station (resident) and the master station (management center) via the door station by pressing or holding down the call button.

Default settings of the call button: when you press the call button, it calls the resident; and when you hold down the call button, it calls the center.

#### **Steps:**

1. Enter the call button settings interface: **Configuration > Video Intercom > Call Button.**

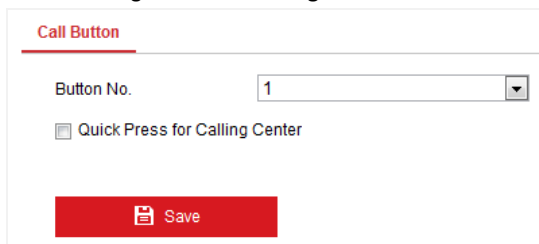

Figure 7-17 Set the Call Button

2. Check the checkbox of **Quick Press for Calling Center** to change the call button mode. After enabling **Quick Press for Calling Center**, when you press the call button, it calls the center, and when you hold down the call button, it calls the resident.

### Supplement Light

#### **Purpose:**

Supplement light function gives you an option to control the IR LED.

#### **Steps:**

1. Enter the call button settings interface: **Configuration > Video Intercom > Supplement Light Settings.**

**Supplement Light Settings**

Working Mode	Video Intercom Device
Supplement Light Mode	Scheduled Switch
Start Time (Day)	00:00:00
End Time (Day)	00:00:00

**Save**

Figure 7-18 Set the Supplement Light

2. Select the working mode for the door station: Video Intercom Device, Front-end Device.

If you select the Video Intercom Device, the door station functions as a video intercom device, while if you select the Front-end Device, the door station functions as a camera only.

3. Select the supplement light mode: Auto, Scheduled Switch.

**Auto:** The camera of the door station switches between the day mode and the night mode according to the illumination automatically.

**Scheduled Switch:** The camera of the door station switches between the day mode and the night mode according to the configured time period.

4. Set the start time (day) and the end time (day).

The start time and the end time require configuring when the supplement light mode is scheduled switch.

The camera of the door station will stay at day mode between the start time and end time.

**Note:**

- The interval between the start time and the end time should be more than 10s.
- The start time should be earlier than the end time.

### 7.3.4 Configuring Network Settings

#### TCP/IP Settings

**Purpose:**

TCP/IP settings must be properly configured before you operate the door station over network. The door station supports the IPv4.

**Steps:**

1. Enter the TCP/IP settings interface: **Configuration > Network > Basic Settings > TCP/IP.**



TCP/IP	Linked Network	Port
	<input type="checkbox"/>	DHCP
IPv4 Address	<input type="text" value="10.15.4.223"/>	
IPv4 Subnet Mask	<input type="text" value="255.255.255.0"/>	
IPv4 Default Gateway	<input type="text" value="10.15.4.254"/>	
<b>DNS Server</b>		
Preferred DNS Server	<input type="text" value="1.8.8.8"/>	
Alternate DNS Server	<input type="text" value="2.114.114.114"/>	
		

Figure 7-19 Set the TCP/IP

2. Set the basic network settings, including IPv4 address, IPv4 subnet mask, and IPv4 default gateway.
3. Set the DNS server. Input the preferred DNS server, and the alternate DNS server.
4. Click **Save** to save the settings.

**Note:**

- Enable DHCP, the door station can obtain an IP address automatically.
- After setting the network parameters, you should close the web browser. Please reopen the web browser and log in again with the new IP address of the door station.

**Linked Network Settings**

**Purpose:**

Linked network parameters involve the IP address of SIP server, the IP address of the center, and the port No. of the center.

Only when the SIP server IP address is configured, can the communication among the door station and the indoor station be realized.

Only when the center IP address is configured, can the door station call the center.

**Steps:**

1. Enter the linked network settings interface: **Configuration > Network > Basic Settings > Linked Network.**

TCP/IP	<u>Linked Network</u>	Port
SIP Server Address		<input type="text" value="0.0.0.0"/>
Center IP Address		<input type="text" value="0.0.0.0"/>
Center Port		<input type="text" value="0"/>
<input type="button" value="Save"/>		

Figure 7-20 Set the Linked Network

2. Set the SIP server address, the center IP address, and the center port.
3. Click **Save** to save the settings.

## Port Settings

### **Purpose:**

You can set the port No. of the door station, e.g. HTTP port, HTTPS port, and server port.

### **Steps:**

1. Enter the port settings interface: **Configuration > Network > Basic Settings > Port.**

TCP/IP	Linked Network	<u>Port</u>
HTTP Port		<input type="text" value="80"/>
HTTPS Port		<input type="text" value="443"/>
Server Port		<input type="text" value="8000"/>
<input type="button" value="Save"/>		

Figure 7-21 Set the Port

2. Set the HTTP port, HTTPS port, and server port of the door station.

**HTTP Port:** The default HTTP port No. is 80, and it can be changed to any port No. which is not occupied. The unoccupied HTTP port ranging from 1 to 65535 is available.

**HTTPS Port:** The default HTTPS port No. is 443, and it can be changed to any port No. which is not occupied. The unoccupied HTTPS port ranging from 1 to 65535 is available.

**Server Port:** The default server port No. is 8000, and it can be changed to any port which is not occupied. The unoccupied server port ranging from 2000 to 65535 is available.

3. Click **Save** to save the settings.

### **Note:**

A reboot is required for the settings to take effect.

## FTP Settings

### Purpose:

You can configure the FTP server related information to enable the uploading of the captured pictures to the FTP server.

### Steps:

1. Enter the FTP Settings interface: **Configuration > Network > Advanced Settings > FTP.**

Figure 7-22 FTP Settings

2. Check the checkbox of **Enable FTP**.
3. Configure the FTP settings; and the user name and password are required for logging in the FTP server.



*For your privacy and to better protect your system against security risks, we strongly recommend the use of strong passwords for all functions and network devices. The password should be something of your own choosing (using a minimum of 8 characters, including at least three of the following categories: upper case letters, lower case letters, numbers and special characters) in order to increase the security of your product. Proper configuration of all passwords and other security settings is the responsibility of the installer and/or end-user.*

**Directory:** In the directory structure, you can select the root directory, parent directory and child directory.

**Anonymous Access to the FTP Server** (The user name and password won't be required.): Check the checkbox of **Anonymous** to enable the anonymous access to the FTP server.

**Note:** The anonymous access function must be supported by the FTP server.

4. Click **Save** to save the settings.

## Email Settings

### Purpose:

The system can be configured to send an Email notification to all designated receivers if an alarm event is detected, e.g., motion detection event.

### Before you start:

Please configure the DNS Server settings under **Configuration > Network > Basic Settings > TCP/IP** before using the Email function.

### Steps:

5. Enter the TCP/IP Settings (**Configuration > Network > Basic Settings > TCP/IP**) to set the IPv4 Address, IPv4 Subnet Mask, IPv4 Default Gateway and the Preferred DNS Server.

**Note:** Please refer to **Configuring TCP/IP Settings** for detailed information.

6. Enter the Email Settings interface: **Configuration > Network > Advanced Settings > Email**.

The screenshot shows the 'Email' configuration page. At the top, there are three tabs: 'FTP', 'Email' (which is active and highlighted in red), and 'HTTPS'. Below the tabs, there are several configuration fields:

- Sender: testipview2016
- Sender's Address: testipview2016@126.com
- SMTP Server: 1.1.1.1
- SMTP Port: 25
- E-mail Encryption: None (dropdown menu)
- Authentication
- User Name: 1234567890123456
- Password: [masked with dots]
- Confirm Password: [masked with dots]

Below the input fields is a table titled 'Receiver' with the following data:

No.	Receiver	Receiver's Address
1	testipview2016	testipview2016@qq.com

At the bottom of the form is a red button with a floppy disk icon and the text 'Save'.

Figure 7-23 Email Settings

7. Configure the following settings:

**Sender:** The name of the email sender.

**Sender's Address:** The email address of the sender.

**SMTP Server:** IP address or host name (e.g., smtp.263xmail.com) of the SMTP Server.

**SMTP Port:** The SMTP port. The default TCP/IP port for SMTP is 25 (not secured).

**E-mail Encryption:** None and SSL are selectable. Select SSL if it is required by the SMTP server.

**Authentication (optional):** If your email server requires authentication, check this checkbox to use authentication to log in to this server and input the login user name and password.



*For your privacy and to better protect your system against security risks, we strongly recommend the use of strong passwords for all functions and network devices. The password should be something of your own choosing (using a minimum of 8 characters, including at least three of the following categories: upper case letters, lower case letters, numbers and special characters) in order to increase the security of your product.*

*Proper configuration of all passwords and other security settings is the responsibility of the installer and/or end-user.*

**The Receiver table:** Select the receiver to which the email is sent. Up to 3 receivers can be configured.

**Receiver:** The name of the user to be notified.

**Receiver's Address:** The email address of user to be notified.

8. Click **Save** to save the settings.

## HTTPS Settings

### **Purpose:**

HTTPS provides authentication of the web site and associated web server that one is communicating with, which protects against Man-in-the-middle attacks. Perform the following steps to set the port number of https.

E.g., if you set the port number as 443 and the IP address is 192.168.1.64, you may access the device by inputting https://192.168.1.64:443 via the web browser.

### **Steps:**

1. Enter the HTTPS settings interface: **Configuration > Network > Advanced Settings > HTTPS.**

The certificate information is presented on the HTTPS settings interface.

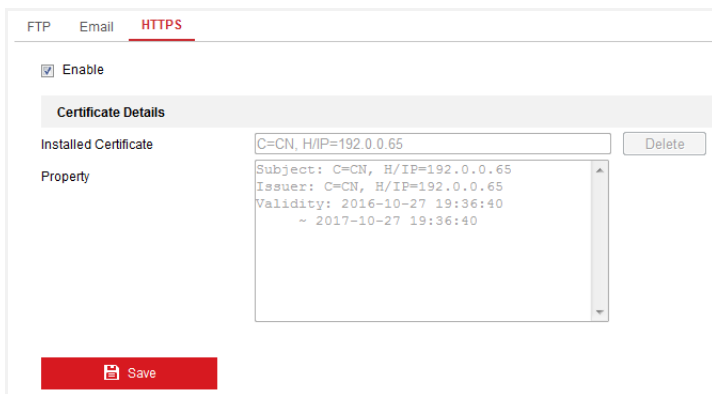

Figure 7-24 HTTPS Settings

2. Check the checkbox of **Enable** to enable the function.
3. Click **Save** to save the settings.

## 7.3.5 Configuring Video/Audio Settings

### Video Settings

#### Steps:

1. Enter the video settings interface: **Configuration > Video/Audio > Video**.

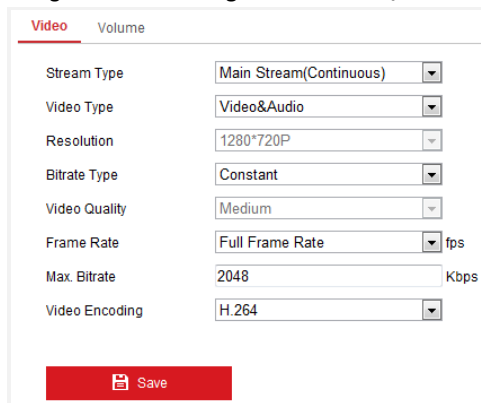

Figure 7-25 Video Settings (Main Stream)

2. Select the stream type of the door station to main stream (continuous) or sub-stream. The main stream is usually for the live view with good bandwidth, and the sub-stream can be used for the live view when the bandwidth is limited.

- Set the following parameters for the selected main stream or sub-stream.

**Video Type:** Select the stream type to video stream, or video & audio composite stream. The audio signal will be recorded only when the Video Type is Video & Audio.

**Resolution:** For the main stream, the resolution of the video output is 1280 x 720P, and for the sub stream, the resolution of the video output is 640 x 480.

**Bitrate Type:** Select the bitrate type to constant or variable.

**Video Quality:** If you set the bitrate type as constant, the video quality is medium. If you set the bitrate type as variable, multiple choices of the video quality can be selected: Lowest, Lower, Low, Medium, Higher, and Highest.

**Frame Rate:** Set the frame rate. The frame rate describes the frequency at which the video stream is updated and it is measured by frames per second (fps). A higher frame rate is advantageous when there is movement in the video stream, as it maintains image quality throughout.

**Max. Bitrate:** Set the max. bitrate. For the main stream, the max. bitrate ranges from 32 to 4096 Kbps, and for the sub stream, the max. bitrate ranges from 32 to 2048 Kbps. The higher value corresponds to the higher video quality, but the better bandwidth is required.

**Video Encoding:** If the stream type is set to main stream, H.264 is selectable, and if the stream type is set to sub stream, H.264 is selectable.

- Click **Save** to save the settings.

## Volume Settings

### Steps:

- Enter the audio settings interface: **Configuration > Video/Audio > Volume.**

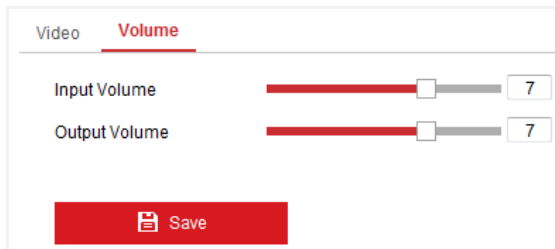

Figure 7-26 Volume Settings

- Configure the input volume and the output volume, both of which range from 0 to 10.
- Click **Save** to save the settings.

## 7.3.6 Configuring Image Parameters

### Display Settings

#### Purpose:

You can set the image quality of the door station, including brightness, contrast, saturation, sharpness, etc.

**Steps:**

1. Enter the display settings interface:

**Configuration > Image> Display Settings**

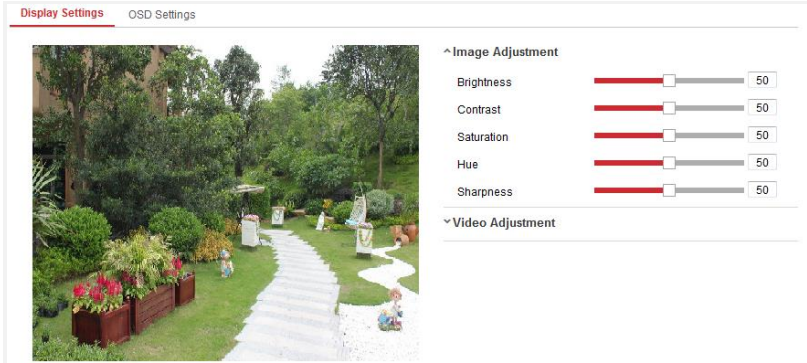

Figure 7-27 Display Settings

2. Set the image parameters of the door station.

- **Image Adjustment**

**Brightness** describes bright of the image, which ranges from 1 to 100, and the default value is 50.

**Contrast** describes the contrast of the image, which ranges from 1 to 100, and the default value is 50.

**Saturation** describes the colorfulness of the image color, which ranges from 1 to 100, and the default value is 50.

**Hue** describes the quality of the image color, which ranges from 1 to 100, and the default value is 50.

**Sharpness** describes the edge contrast of the image, which ranges from 1 to 100, and the default value is 50.

- **Video Adjustment**

**Video Standard:** 50 Hz and 60 Hz are selectable. Choose according to the different video standards. Normally, 50 Hz is for PAL standard and 60 Hz for NTSC standard.

## OSD Settings

**Purpose:**

OSD (On-screen Display) refers to the camera name, time/date format, and display mode on the live view.

**Steps:**



1. Enter the OSD Settings interface: **Configuration > Image > OSD Settings.**

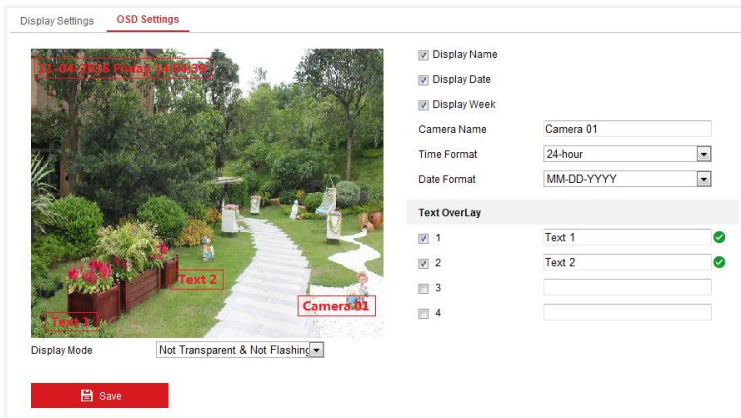

Figure 7-28 OSD Settings

2. Check the corresponding checkbox to select the display of camera name, date or week if required.
  3. Edit the camera name in the text field of Camera Name.
  4. Select from the drop-down list to set the time format, date format, and display mode.
  5. Set overlaid text if needed.
    - 1) Check the checkbox on the left to enable the on-screen display.
    - 2) Input the desired information in the textbox.
- Notes:** Up to 4 texts are configurable.
6. You can use the mouse to click-and-drag the red text frames in the live view window to adjust the OSD position.
  7. Click **Save** to save the settings.

### 7.3.7 Configuring Event Settings

#### Motion Detection

**Purpose:**

Motion detection detects the moving objects in the configured surveillance area, and a series of actions can be taken when the alarm is triggered.

Motion detection configuration adopts the same set of motion detection parameters in the daytime and at night.

**Tasks 1: Set the Motion Detection Area**

**Steps:**

1. Enter the motion detection settings interface: **Configuration > Event > Basic Event > Motion Detection.**

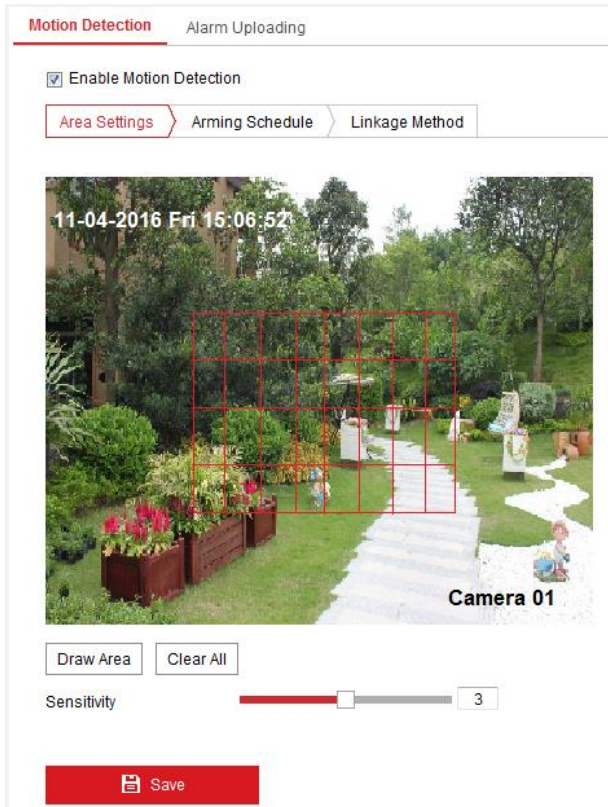

Figure 7-29 Motion Detection Settings

2. Check the checkbox of **Enable Motion Detection**.
3. Click **Draw Area**. Drag the mouse on the live video to draw a motion detection area. Click **Stop Drawing** to finish drawing one area.
4. (Optional) Click **Clear All** to clear all of the areas.
5. (Optional) Move the slider to set the sensitivity of the detection.

**Task 2: Set the Arming Schedule for Motion Detection**

**Steps:**

1. Click **Arming Schedule** to edit the arming schedule.

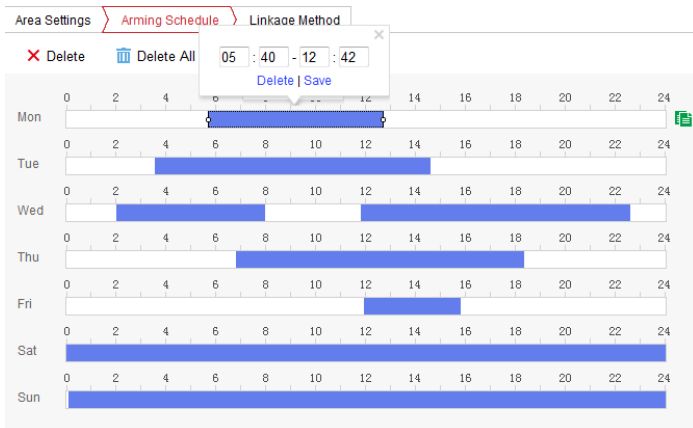

Figure 7-30 Arming Schedule Setting

- Click on the time bar and drag the mouse to select the time period.

**Note:** Click on the selected time period, you can adjust the time period to the desired time by either moving the time bar or input the exact time period.

- (Optional) Click **Delete** to delete the current arming schedule, or click **Save** to save the settings.
- Move the mouse to end of each day, a green copy icon appears. You can click the icon to copy the current time schedule to other days.

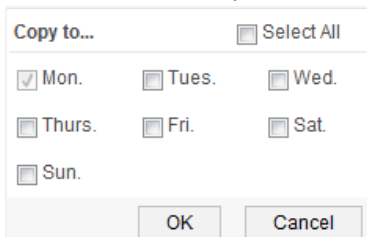

Figure 7-31 Copy to Window

- Click **Save** to save the settings.

**Note:** The time of each period can't be overlapped. Up to 8 periods can be configured for each day.

### **Task 3: Set the Linkage Method for Motion Detection**

Click **Linkage Method** and check the checkbox to select the linkage method. Send email, notify surveillance center, and upload to FTP are selectable.

Motion Detection    Alarm Uploading

---

Enable Motion Detection

Area Settings > Arming Schedule > **Linkage Method**

Normal Linkage

Send Email

Notify Surveillance Center

Upload to FTP

Save

Figure 7-32 Linkage Method Settings

**Notify Surveillance Center:** Send an exception or alarm signal to remote management software when an event occurs.

**Send Email:** Send an email with alarm information to a user or users when an event occurs.

**Note:** To send the Email when an event occurs, please refer to Section 5.3.8 to complete Email setup in advance.

**Upload to FTP:** Capture the image when an alarm is triggered and upload the picture to the configured FTP server.

**Notes:** Set the FTP address and the remote FTP server first. Refer to Section 5.3.7 Configuring FTP Settings for detailed information.

### Alarm Uploading

**Purpose:**

Delayed door alarm will be triggered when the door is unlocked beyond the door-unlocked duration.

**Steps:**

1. Enter the alarm uploading settings interface: **Configuration > Event > Basic Event > Alarm Uploading.**

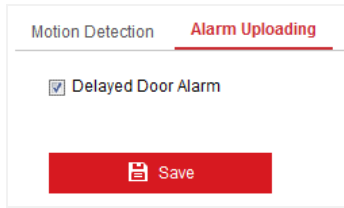

Figure 7-33 Alarm Uploading Settings

2. Check the checkbox of **Delayed Door Alarm**.
3. Click **Save** to save the settings.

## 8 Remote Operation via Batch Configuration Tool

### Purpose:

You can operate configure the device remotely via the Batch Configuration Tool. Before operating and configuring the device via the Batch Configuration Tool, you should activate the device first. For detail information about activation, please refer to 5 *Activating Door Station*.

### 8.1 Editing Network Parameters

#### Purpose:

To operate and configure the device via LAN (Local Area Network), you need connect the device in the same subnet with you PC. You can edit network parameters via batch configuration tool, and iVMS-4200 client software. Here take editing network parameters via batch configuration tool as example.

#### Steps:

1. Select an online activated device and click **Edit NET Parameters**.

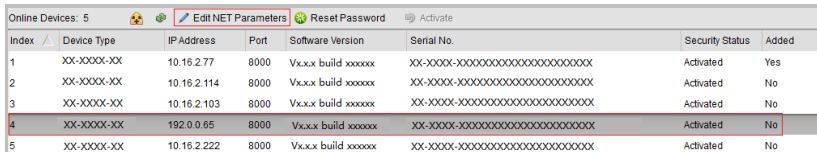

Index	Device Type	IP Address	Port	Software Version	Serial No.	Security Status	Added
1	XX-XXXX-XX	10.16.2.77	8000	Vi.c.c.k build xxxxxx	XX-XXXX-XXXXXXXXXXXXXXXXXXXXXXXXXX	Activated	Yes
2	XX-XXXX-XX	10.16.2.114	8000	Vi.c.c.k build xxxxxx	XX-XXXX-XXXXXXXXXXXXXXXXXXXXXXXXXX	Activated	No
3	XX-XXXX-XX	10.16.2.103	8000	Vi.c.c.k build xxxxxx	XX-XXXX-XXXXXXXXXXXXXXXXXXXXXXXXXX	Activated	No
4	XX-XXXX-XX	192.0.0.65	8000	Vi.c.c.k build xxxxxx	XX-XXXX-XXXXXXXXXXXXXXXXXXXXXXXXXX	Activated	No
5	XX-XXXX-XX	10.16.2.222	8000	Vi.c.c.k build xxxxxx	XX-XXXX-XXXXXXXXXXXXXXXXXXXXXXXXXX	Activated	No

Figure 8-1 Click Edit NET Parameters Button

2. Change the device IP address and gateway address to the same subnet with your computer. Or enable **DHCP** to get the IP address automatically.
3. Input the password and click **OK** to activate the network parameters modification.

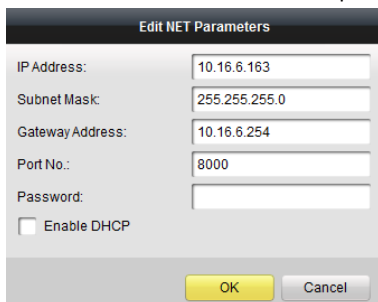

Edit NET Parameters

IP Address:

Subnet Mask:

Gateway Address:

Port No.:

Password:

Enable DHCP

Figure 8-2 Edit Network Parameters

**Note:**

- The default port No. is 8000.
- After editing the network parameters of device, you should add the devices to the device list again.

## 8.2 Adding Device

**Before you start:**

Make sure the device to be added has been activated.

**Purpose:**

To configure the activated device via batch configuration tool and iVMS-4200 client software remotely, you should add the device to the tool or the software firstly. 3 ways for adding the device are supported: adding active online devices within your subnet, adding device by IP address, and adding device by IP segment.

### 8.2.1 Adding Online Device

**Before you start:**

Make sure the device to be added is in the same subnet with your computer. Otherwise, please edit network parameters first.

**Steps:**

1. Select an active online device or hold the **Ctrl** or **Shift** key to select multiple devices in the online devices list.

Index	Device Type	IP Address	Port	Software Version	Serial No.	Security Status	Added
1	XX-XXXX-XX	10.16.2.77	8000	Vx.x.x build xxxxxx	XX-XXXX-XXXXXXXXXXXXXXXXXXXXXXXXXX	Activated	Yes
2	XX-XXXX-XX	10.16.2.114	8000	Vx.x.x build xxxxxx	XX-XXXX-XXXXXXXXXXXXXXXXXXXXXXXXXX	Activated	No
3	XX-XXXX-XX	10.16.2.103	8000	Vx.x.x build xxxxxx	XX-XXXX-XXXXXXXXXXXXXXXXXXXXXXXXXX	Activated	No
4	XX-XXXX-XX	10.16.2.88	8000	Vx.x.x build xxxxxx	XX-XXXX-XXXXXXXXXXXXXXXXXXXXXXXXXX	Activated	No
5	XX-XXXX-XX	10.16.2.222	8000	Vx.x.x build xxxxxx	XX-XXXX-XXXXXXXXXXXXXXXXXXXXXXXXXX	Activated	No

Figure 8-3 Online Devices Interface

2. Click  to pop up the login dialog box.

**Login**

**Log into the selected device(s):**

User Name:

Password:

Figure 8-4 Login Dialog Box

3. Input the user name and password.
4. Click **OK** to save the settings.

**Note:**

- Only devices successfully logged in will be added to the device list for configuration.
- If you add devices in batch, please make sure selected devices have the same user name and password.

### 8.2.2 Adding by IP Address

**Purpose:**

You can add the device by inputting IP address.

**Steps:**

1. Click  to pop up the adding devices dialog box.

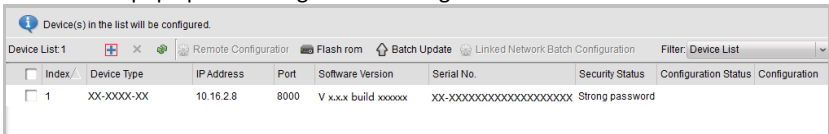

Figure 8-5 Click Adding Button

2. Select IP Address in the adding mode drop-down list.
3. Input the IP address, and set the port No., user name and password of the device.

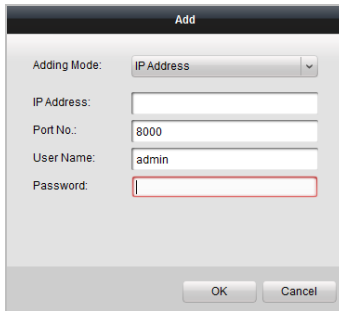

Figure 8-6 Adding by IP Address

4. Click **OK** to add the device to the device list.

**Note:**

- You cannot add the device(s) to the device list if the user name and password are not identical.
- When you add devices by IP Address, IP Segment or Port No., the devices should be online devices.

### 8.2.3 Adding by IP Segment

**Purpose:**



You can add many devices at once whose IP addresses are among the IP segment.

**Steps:**

1. Click  to pop up the adding devices dialog box.

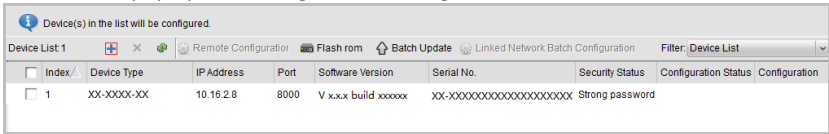

Figure 8-7 Click Adding Button

2. Select IP Segment in the adding mode drop-down list.
3. Set the Start IP Address and End IP Address.
4. Input port No., user name, and password.

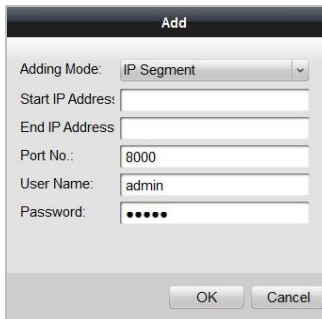



Figure 8-8 Adding by IP Segment

5. Click **OK** to search and add the devices whose IP addresses are within the range of the defined IP segment to the device list.

### 8.3 Configuring Devices Remotely

In the device list area, select a device and click  **Remote Configuration** or  to enter the remote configuration interface.

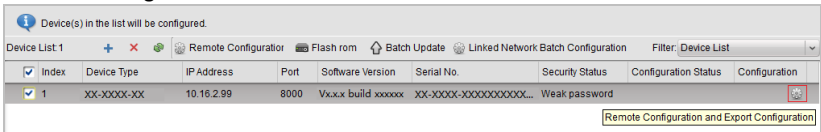



Figure 8-9 Remote Configuration

**Note:** The icon  appears by hovering the mouse over a piece of device information.

#### 8.3.1 System

Click **System** on the remote configuration interface to display the device information: Device Information, General, Time, System Maintenance, and User, and so on.

## Device Information

Click **System** → **Device Information** to enter device basic information interface. You can view basic information (the device type, and serial No.), and version information of the device.

**Displaying the Device Information**

**Basic Information**

Device Type: XX-XXXX-XX

Device Serial No.: XX-XXXX-XXXXXXXXXXXXXXXXXXXXXX

**Version Information**

Version: Vx.x.x build xxxxxx

Hardware Version: xxxxxx

Figure 8-10 Device Information

## General

Click **System** → **General** to enter device general parameters settings interface. You can view and edit the device name and device ID.

**Configuring the General Parameters**

**Device Information**

Device Name: Embedded Net VIS

Device No.: 255

Save

Figure 8-11 General

## Time

### Steps:

1. Click **System** → **Time** to enter the device time settings interface.

Figure 8-12 Time Settings

2. Select Time Zone or Enable NTP.

- **Time Zone**

- 1) Select a time zone from the drop-down list menu.
- 2) Click the **Synchronization** button.

- **NTP**

- 1) Check the checkbox of Enable NTP to enable NTP.
- 2) Input the server address, NTP port, and synchronization interval.

- **DST**

- 1) Check the checkbox of Enable DST to enable DST.
- 2) Input the start time and end time of DST, and set the DST bias.

3. Click **Save** to save and realize the time settings.

**Note:** The default port No. is 123.

## System Maintenance

### **Purpose:**

You can operate the system management and remote upgrading on the system maintenance interface.

### **Steps:**

1. Click **System** → **System Maintenance** to enter the system maintenance interface.

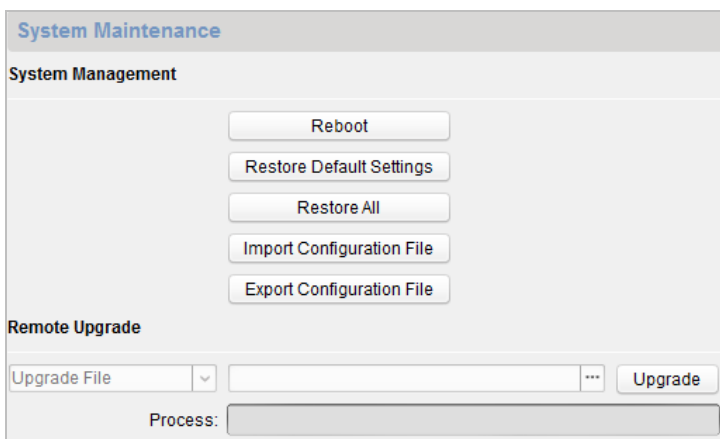

Figure 8-13 System Maintenance

2. Click **Reboot** and the system reboot dialog box pops up. Click **Yes** to reboot the system.
3. Click **Restore Default Settings** to restore the default parameters.
4. Click **Restore All** to restore all parameters of device and reset the device to inactive status.
5. Click **Import Configuration File** and the import file window pops up. Select the path of remote configuration files. Click **Open** to import the remote configuration file. The configuration file is imported and the device will reboot automatically.

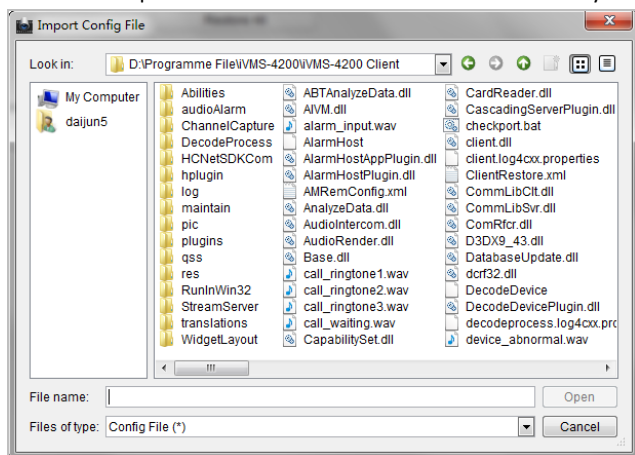

Figure 8-14 Import File

6. Click **Export Configuration File** and the export file window pops up. Select the saving path of remote configuration files and click **Save** to export the configuration file.

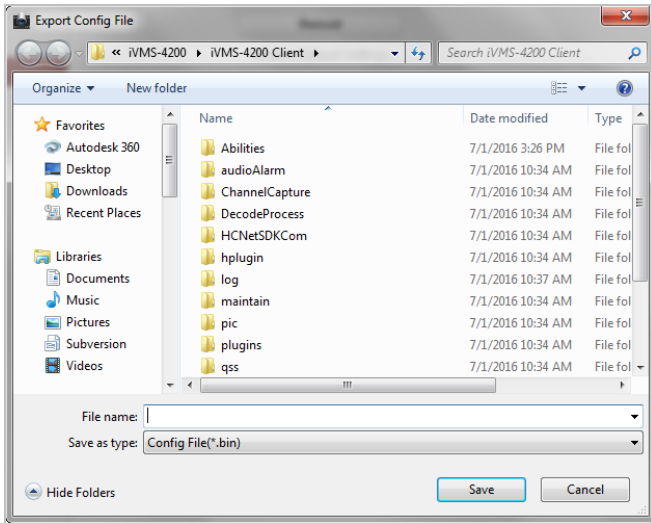



Figure 8-15 Export File

- Click  to select the upgrade file and click **Upgrade** to remote upgrade the device. The process of remote upgrade will be displayed in the process bar.

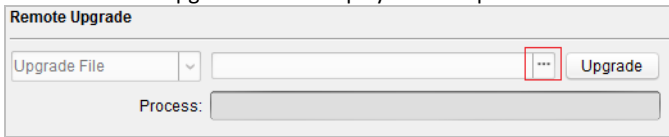

Figure 8-16 Remote Upgrade

**Note:**

- By clicking **Restore Default Settings**, all default settings, excluding network parameters and user information, will be restored.
- By clicking **Restore All**, all default settings, including network parameters and user information, will be restored. The device will be reset to inactivated status.

**User**

**Purpose:**

You can edit the password for logging in the device.

**Steps:**

1. Click **System** → **User** to enter the user information editing interface.

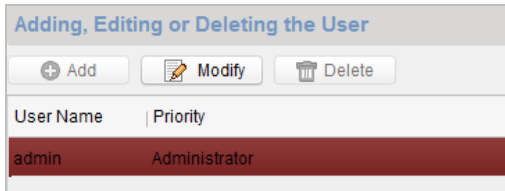

Figure 8-17 Select User Name

2. Select the user to edit and click **Modify** to enter the user parameter interface.

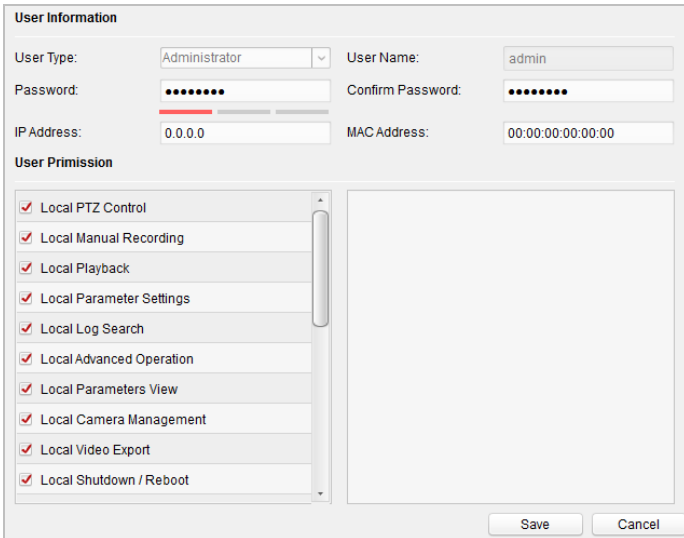



Figure 8-18 Modify User Information

3. Input the new password, and confirm it.
4. Click **Save** to realize the editing of password.

**Note:**

- The new password and confirm password should be identical.
- After editing the password of device, click  button from the device list, the added device will not be there. You should add the device again with new password to operate the remote configuration.

### 8.3.2 Video Intercom

Click **Video Intercom** on the remote configuration interface to enter the video intercom parameters settings: Device Number Configuration, Time Parameters, Password, Zone Configuration, IP Camera Information, and Volume Input and Output Configuration, and so on.

## ID Configuration

### **Purpose:**

To call the door station via the client software or to call indoor stations/the client software/the master station via the door station successfully, you should number the door station first. You should set the community No., the building No., the unit No., and the floor No. for the door station.

The door station supports 2 kinds of device type: villa door station and doorphone. When it works as a doorphone, there is no need setting the community No., the building No., the unit No., the floor No. or the device No..

### **Steps:**

1. Click **Video Intercom** → **ID Configuration** to enter device ID configuration interface.

The screenshot shows a web-based configuration window titled "Device No. Configuration". It contains the following fields and controls:

- Device Type:** A dropdown menu with "Door Station (V Series)" selected.
- Community No.:** A text input field containing the number "1".
- Building No.:** A text input field containing the number "1".
- Unit No.:** A text input field containing the number "1".
- Floor No.:** A text input field containing the number "1".
- No.:** A text input field containing the number "0".
- Save:** A button located at the bottom center of the form.

Figure 8-19 Door Station (V Series)

2. Select the device type from the drop-down list, and set the corresponding information.
3. Click **Save** to enable the device number configuration.

### **Note:**

- For main door station, the serial No. is 0.
- For sub door station, the serial No. is larger than 0. Serial No. ranges from 1 to 99.
- For each villa or building, at least one main door station should be configured, and sub door stations can be customized.
- For one main door station, at most 8 sub door stations can be customized.
- Select doorphone as device type, and the serial No. is not necessary to configure. Please utilize the doorphone along with the main door station (V Series or D Series).
- V series door station cannot be used as outer door station.

## Time Parameters

### **Steps:**

1. Click **Video Intercom** → **Time Parameters** to enter time parameters settings interface.
2. Configure the maximum speaking duration, and the maximum message duration.
3. Click **Save**.

Figure 8-20 Time Parameters

**Note:** For door station, maximum speaking time and maximum message time should be configured. Maximum speaking time varies from 90s to 120s, and maximum message time varies from 30s to 60s.

### Access Control and Elevator

**Steps:**

1. Click **Video Intercom** → **Access Control and Elevator** to enter the access control and elevator settings interface.

**Note:** The door station does not support the elevator controlling function.

Figure 8-21 Access Control and Elevator Settings

2. Select the door No.
3. Set the door-unlocked duration.

**Note:** If you set the door-unlocked duration, after you open the door, the door will be locked automatically beyond the set duration.

4. (Optional) Enable **Delay Door Alarm**.

**Note:** Delayed door alarm will be triggered when the door is unlocked beyond the door-unlocked duration.

5. Click **Save** to enable the settings.



**Note:** This function only applies to door stations, except for the doorphone.

## IO Input and Output

IO input/output refers to the Alarm In terminal and the Alarm Out terminal. You can connect external devices to the door station via these terminals. The door station has 1 Alarm In terminal (AI), and 1 Alarm Out terminal (NO/COM/NC).

### Steps:

1. Click **Video Intercom -> IO Input and Output** to enter the IO input and output interface.

The screenshot shows a configuration window with the following fields:

- IO Input Section:**
  - IO Input No.: AI
  - Input: Exit Button
- IO Output Section:**
  - IO Output No.: COM
  - Output: Electric Lock
- Buttons:** A 'Save' button is positioned at the bottom center of the configuration area.

Figure 8-22 IO Input/Output Configuration

2. Set the input mode: Disabled, Exit Button, Door Status, Custom.

**Disabled:** The function of the AI terminal is disabled.

**Exit Button:** The AI terminal supports connecting to the exit button.

**Door Status:** The AI terminal supports connecting to the door magnetic.

**Custom:** It is reserved.

3. Set the output mode: Disabled, Electric Lock, Custom.

**Disabled:** The function of the NO/NC/COM terminal is disabled.

**Electric Lock:** The NO/NC/COM terminal supports connecting to the electric lock (electric strike, and magnetic lock).

**Custom:** It is reserved.

4. Click **Save** to enable the settings.

## Volume Input and Output

### Steps:

1. Click **Video Intercom -> Volume Input/Output** to enter the volume input and output interface.

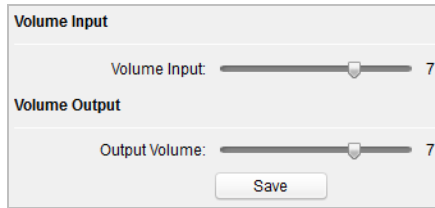

Figure 8-23 Volume Configuration

2. Slide the slider to adjust the volume input and volume output.
3. Click **Save** to enable the settings.

## Call Button

### Steps:

1. Click **Video Intercom** -> **Call Button** to enter the call button settings interface.

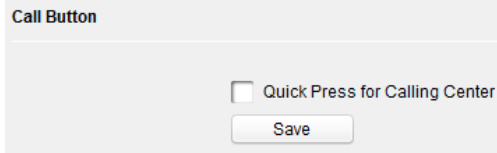

Figure 7-1 Call Button Settings Interface

2. Check the checkbox of **Quick Press for Calling Center**.
3. Click **Save** to enable the settings.

**Note:** If enabling **Quick Press for Calling Center**, you should call resident by holding down the call button, and call center by quickly pressing the call button.

## Motion Detection

### Purpose:

Motion detection detects the moving objects in the configured surveillance area, and a series of actions can be taken when the alarm is triggered.

Motion detection configuration adopts the same set of motion detection parameters in the daytime and at night.

### Task 1: Set the Motion Detection Area

#### Steps:

1. Click **Video Intercom** -> **Motion Detection** to enter the motion detection settings interface.

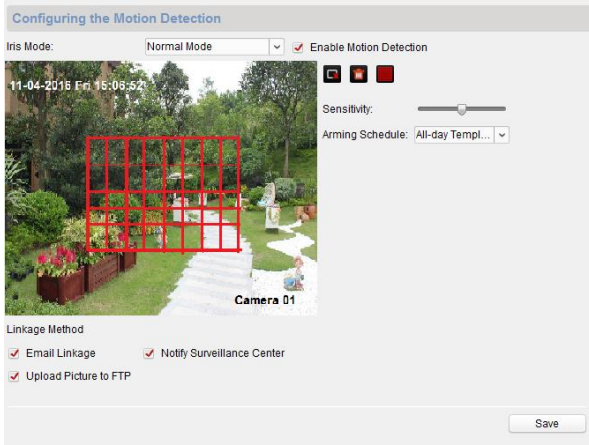





Figure 7-2 Motion Detection Settings Interface

2. Check the checkbox of **Enable Motion Detection**.
3. Click and drag the mouse on the live video to draw motion detection area.
4. (Optional) Click , then the whole live video screen belongs to the draw motion detection area.
5. (Optional) Click  to delete the selected motion detection area.
6. (Optional) Click  to delete all motion detection areas.
7. (Optional) Move the slider to set the sensitivity of the detection.

### **Task 2: Set the Arming Schedule for the Motion Detection**

#### **Steps:**

1. Click the arming schedule drop-down list to enter the arming schedule settings interface.

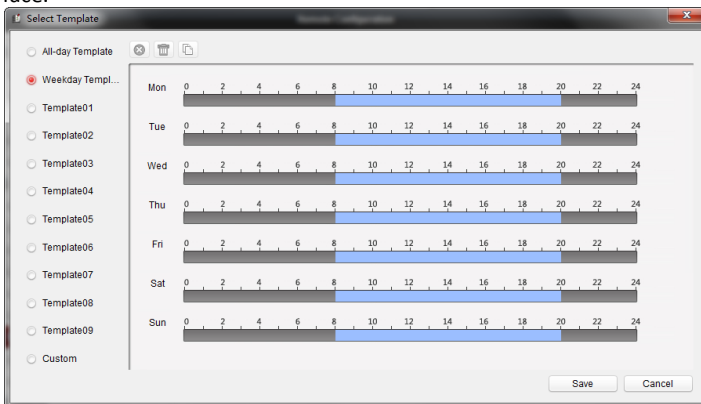

Figure 7-3 Arming Schedule Settings

2. Edit a template and save it.

**Note:** Up to 9 templates are supported to be set manually.

- 1) Select a template, e.g., Template 01, and click Edit on the upper right corner to the template editing interface.

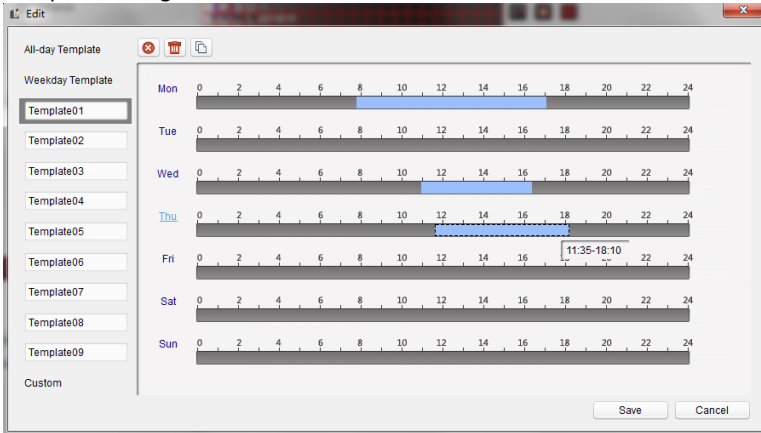

Figure 7-4 Template Editing Interface

- 2) Click on the time bar and drag the mouse to the time period.

**Note:** Click on the selected time period, you can adjust the time period to the desired time by either moving the time bar or input the exact time period.

- 3) Select a time period, click to delete the selected one.
- 4) Click to delete all configured time periods.
- 5) Select a time period, click to copy the selected time period to other days.

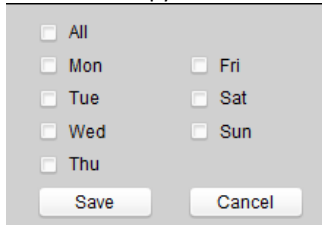

Figure 7-5 Copy to

- 6) (Optional) You can rename the template 1.
- 7) Click **save** the save the settings.

**Note:** The time of each period can't be overlapped. Up to 8 periods can be configured for each day.

3. (Optional) You can select **All-day Template** or **Weekday Template**.  
**All-day Template:** The motion detection area is armed all the day.

**Weekday Template:** The motion detection area is armed during the working time period of each day. The working time period here is from 8 am to 8 pm.

- (Optional) If you select **Custom**, you should manually set the time period. The way is same with the settings of template 1.

### **Task 3: Set the Linkage Method for Motion Detection**

Check the checkbox to select the linkage method. Send email, notify surveillance center, and upload to FTP are selectable.

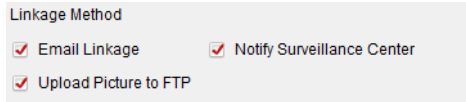

Linkage Method

Email Linkage       Notify Surveillance Center

Upload Picture to FTP

Figure 8-24 Linkage Method Settings

**Notify Surveillance Center:** Send an exception or alarm signal to remote management software when an event occurs.

**Email Linkage:** Send an email with alarm information to a user or users when an event occurs.

**Note:** To send the Email when an event occurs, please complete the Email configuration in advance in Section 8.3.3.

**Upload Picture to FTP:** Capture the image when an alarm is triggered and upload the picture to the configured FTP server.

**Notes:** Set the FTP address and the remote FTP server first. Please complete the FTP configuration in advance in Section 8.3.3.

## Working Mode

Click **Video Intercom -> Work Mode** to enter the working mode settings interface.

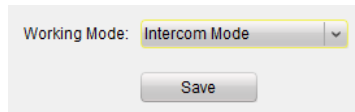

Working Mode: Intercom Mode

Save

Figure 7-6 Working Mode Settings Interface

If you select the **Intercom Mode**, the door station functions as a video intercom device, while if you select the **IPC Mode**, the door station functions as a camera only.

## Supplement Light

### **Steps:**

1. Click **Video Intercom -> Supplement Light** to enter the supplement light mode settings interface.

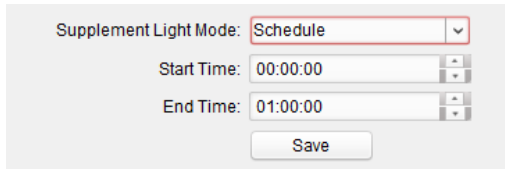

The image shows a settings interface for the Supplement Light Mode. It features a dropdown menu for 'Supplement Light Mode' set to 'Schedule'. Below it are two time input fields: 'Start Time' set to '00:00:00' and 'End Time' set to '01:00:00'. A 'Save' button is located at the bottom.

Figure 7-7 Supplement Light Mode Settings Interface

2. Select the supplement light mode: Auto, Schedule.

**Auto:** The camera of the door station switches between the day mode and the night mode according to the illumination automatically.

**Schedule:** The camera of the door station switches between the day mode and the night mode according to the configured time period.

3. Set the start time (day) and the end time (day).

The start time and the end time require configuring when the supplement light mode is scheduled switch.

The camera of the door station will stay at day mode during the start time and end time.

**Note:**

- The interval between the start time and the end time should be more than 10s.
- The start time should be earlier than the end time.

### 8.3.3 Network

#### Local Network Configuration

**Steps:**

1. Click **Network** -> **Local Network Configuration** to enter local network configuration interface.

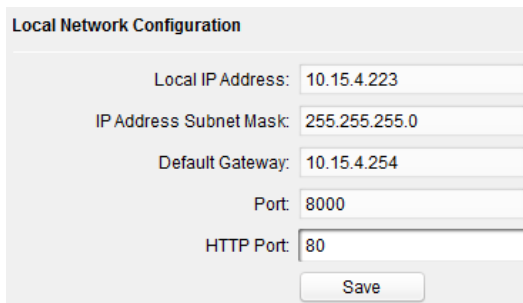

The image shows the 'Local Network Configuration' interface. It contains five input fields: 'Local IP Address' (10.15.4.223), 'IP Address Subnet Mask' (255.255.255.0), 'Default Gateway' (10.15.4.254), 'Port' (8000), and 'HTTP Port' (80). A 'Save' button is at the bottom.

Figure 8-25 Local Network Parameters

2. Input the local IP address, subnet mask, gateway address, port No., and HTTP port.
3. Click **Save** to enable the settings.

**Note:**

- The default port No. is 8000, and the default HTTP port No. is 80.

- After editing the local network parameters of device, you should add the devices to the device list again.

### Linked Devices Network Configuration

#### **Purpose:**

In the linked devices network configuration interface, you can configure the network parameters of master stations, SIP servers and management centers of the same LAN. The devices can be linked to the door station and realize the linkage between these devices.

#### **Steps:**

1. Click **Network** -> **Linked Network Configuration** to enter linked network configuration interface.

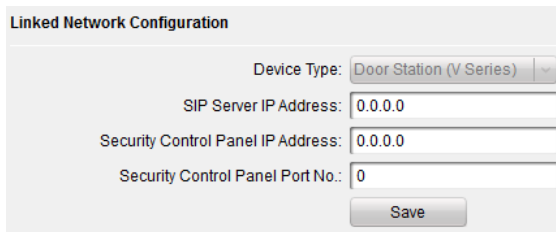

Figure 8-26 Linked Network Configuration

2. Input the SIP server IP address, the management center IP address, and the management center port No..
3. Click **Save** to enable the settings.

#### **Note:**

- After adding SIP Server Address IP, the video intercom of same community: video intercom between indoor stations of different building, calling indoor station from outer door station and video intercom between management center and indoors.
- After adding management center IP Address, the events can be uploaded to the management center.

### FTP

#### **Steps:**

1. Click **Network** -> **FTP** to enter the FTP parameters interface.

Figure 8-27 FTP Configuration

2. Check the checkbox of **Enable Main FTP**.
3. Select IP address from the drop-down list of server mode.
4. Input the FTP server address, and port No..
5. Check the checkbox to enable the anonymity (optional).
6. Input the name and password.
7. Select the directory structure and set the separator, naming item, and naming element.
8. Click **Save** to enable the FTP parameters settings.

**Note:**

- The default port No. is 21.
- To enable anonymity or not is according to whether the FTP server enables anonymity.
- After configuring the FTP parameters, the captured pictures of door station will be uploaded to the FTP server automatically.
- This function only applies to the door station, except for the doorphone.

**Email**

**Purpose:**

The system can be configured to send an Email notification to all designated receivers if an alarm event is detected, e.g., motion detection event.

**Before you start:**

Please configure the local network parameters and the DNS Server settings before using the Email function.

**Steps:**

1. Set the local IP address, subnet mask, and default gateway in Local Network Configuration interface.



2. Set the DNS server address in the Advanced Settings interface.
3. Click **Network -> Email** to enter the email settings interface.

The screenshot shows the 'Email' configuration window. It contains the following elements:

- User Name:** Text input field.
- Password:** Text input field.
- Confirm Password:** Text input field.
- Server Authentication:** A checkbox.
- Sender/Recipient Details:** A table with columns 'User Type', 'User Name', and 'Address'. It has two rows: 'Sender' and 'Receiver 1'.
- SMTP Server:** Text input field containing '1.1.1.1'.
- Port:** Text input field containing '25'.
- E-mail Encryption:** A dropdown menu set to 'Close'.
- Buttons:** 'Modify', 'Clear', and 'Save'.

Figure 8-28 Email Configuration

4. Input the user name, password, and confirm the password.
5. Set the sender/recipient details.
  - 1) Select **Sender** or **Receiver**, and click **Modify** to pop up the information settings window.

The screenshot shows a dialog box titled 'Email Settings'. It contains the following elements:

- User Name:** Text input field.
- Email Address:** Text input field.
- Buttons:** 'Save' and 'Cancel'.

Figure 8-29 Information Settings

- 2) Input the user name, and the email address.
6. Set the following parameters.
  - SMTP Server:** IP address or host name (e.g., smtp.263xmail.com) of the SMTP Server.
  - SMTP Port:** The SMTP port. The default TCP/IP port for SMTP is 25 (not secured).
  - E-mail Encryption:** Close and SSL are selectable. Select SSL if it is required by the SMTP server.
  - Server Authentication (optional):** If your email server requires authentication, check this checkbox to use authentication to log in to this server and input the login user name and password.



*For your privacy and to better protect your system against security risks, we strongly recommend the use of strong passwords for all functions and network devices. The password should be something of your own choosing (using a minimum of 8 characters, including at least three of the following categories: upper case letters, lower case letters, numbers and special characters) in order to increase the security of your product.*

*Proper configuration of all passwords and other security settings is the responsibility of the installer and/or end-user.*

7. Click **Save** to save the settings.

## HTTPS

### Steps:

1. Click **Network -> HTTPS** to enter the HTTPS parameters interface.

Figure 8-30 HTTPS Configuration

2. Check the checkbox of **Enable HTTPS**.
3. Click **Save** to save the settings.

**Note:** The default HTTPS port No. is 443.

## Advanced Settings

In the advanced settings interface, you can configure the DNS server.

### Steps:

1. Click **Network -> Advanced Settings** to enter the DNS server settings interface.

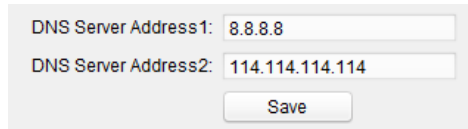

DNS Server Address1: 8.8.8.8

DNS Server Address2: 114.114.114.114

Save

Figure 8-31 DNS Server Settings Interface

2. Set the DNS server address 1 and the DNS server address 2.
3. Click **Save** to save the settings.

### 8.3.4 Video Display

#### Video Parameters

**Steps:**

1. Click **Video Display** -> **Video Parameters** to enter the video parameters interface.

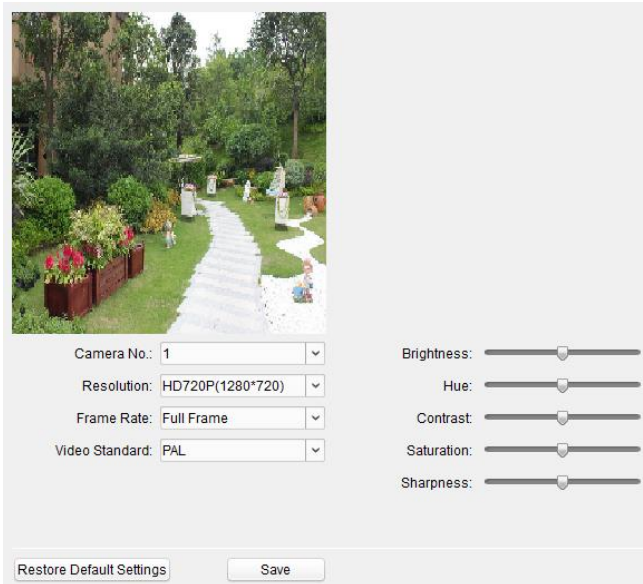

Camera No.: 1

Resolution: HD720P(1280\*720)

Frame Rate: Full Frame

Video Standard: PAL

Brightness:

Hue:

Contrast:

Saturation:

Sharpness:

Restore Default Settings Save

Figure 8-32 Video Display

2. Select the channel No..
3. Select the resolution, the frame rate, and the video standard (PAL and NTSC can be selected).
4. Set the brightness, contrast, hue, sharpness, and saturation of the video.
5. Click **Save** to enable the settings.

**Note:**

Click **Restore Default Settings** to restore all parameters, excluding network parameters and user information, to the factory settings.

### Video Display (OSD Settings)

#### **Purpose:**

On the video display interface, you can set OSD (On-screen Display) parameters, including the camera name, time/date format, and display mode on the live view.

#### **Steps:**

1. Click **Video Display** -> **Video Display** to enter the video display interface.

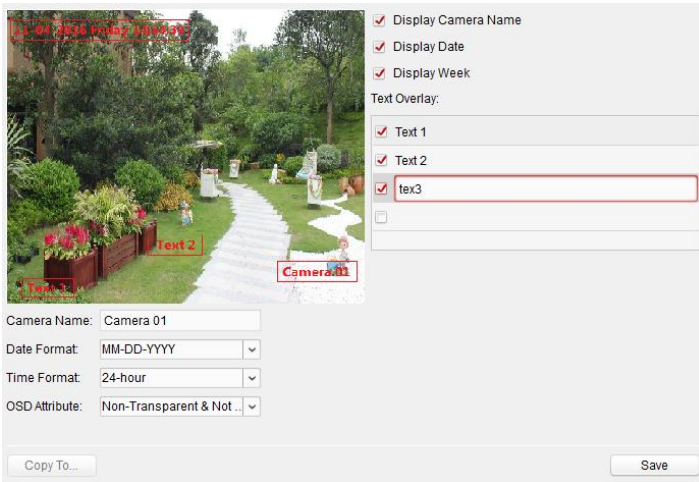

Figure 8-33 Video Display (OSD Settings)

2. Check the corresponding checkbox to select the display of camera name, date or week if required.
3. Edit the camera name in the text field of Camera Name.
4. Select from the drop-down list to set the date format, the time format, and the OSD attribute.
5. Set overlaid text if needed. Input the desired information in the textbox.  
**Notes:** Up to 4 texts are configurable.
6. You can use the mouse to drag the red text frames in the live view window to adjust the OSD position.
7. Click **Save** to save the settings.

### Video & Audio

#### **Steps:**

1. Click **Video Display** -> **Video & Audio** to enter the video/audio settings interface.

Stream Type: Main Stream  
 Video Type: Video & Audio  
 Bitrate Type: Constant  
 Bitrate: 2048 Kbps  
 Video Quality: Medium  
 Resolution: HD720P(1280\*720)  
 Frame Rate: Full Frame  
 I Frame Interval: 25  
 Audio Encoding Type: G711\_U  
 Video Encoding Type: STD\_H264  
 File Size Per Day: 0.3G

Copy to... Save

Figure 8-34 Video/Audio Settings (Main Stream)

2. Select the stream type of the door station to main stream or sub-stream.

The main stream is usually for the live view with good bandwidth, and the sub-stream can be used for the live view when the bandwidth is limited.

3. Set the following parameters for the selected main stream or sub-stream.

**Video Type:** Select the stream type to video stream, or video & audio composite stream. The audio signal will be recorded only when the Video Type is Video & Audio.

**Resolution:** For the main stream, the resolution of the video output is 1280 x 720P, and for the sub stream, the resolution of the video output is 640 x 480.

**Bitrate Type:** Select the bitrate type to constant or variable.

**Video Quality:** If you set the bitrate type as constant, the video quality is medium. If you set the bitrate type as variable, multiple choices of the video quality can be selected: Lowest, Lower, Low, Medium, Higher, and Highest.

**Frame Rate:** Set the frame rate. The frame rate describes the frequency at which the video stream is updated and it is measured by frames per second (fps). A higher frame rate is advantageous when there is movement in the video stream, as it maintains image quality throughout.

**Max. Bitrate:** Set the max. bitrate. For the main stream, the max. bitrate ranges from 32 to 4096 Kbps, and for the sub stream, the max. bitrate ranges from 32 to 2048 Kbps. The higher value corresponds to the higher video quality, but the better bandwidth is required.

**Video Encoding:** If the stream type is set to main stream, H.264 is selectable, and if the stream type is set to sub stream, H.264 is selectable.

4. Click **Save** to save the settings.

## 8.4 Video Intercom Device Set-up Tool

### **Purpose:**

You can assign the device to the community, activate and set the device, and configure the network parameters and linked network parameters for the device by using the video intercom device set-up tool.

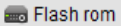
In the device list area, click  **Flash rom** to enter the video intercom device set-up tool.

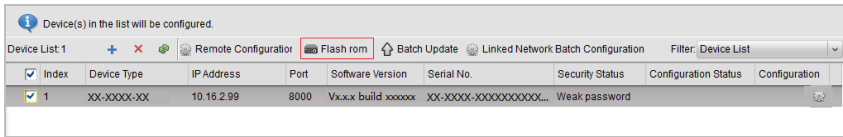

Figure 8-35 Video Device Set-up Tool

### 8.4.1 Setting a Community Structure

Set a community structure in the video intercom device set-up tool first, based on the real community situation, and then assign devices to the community accordingly.

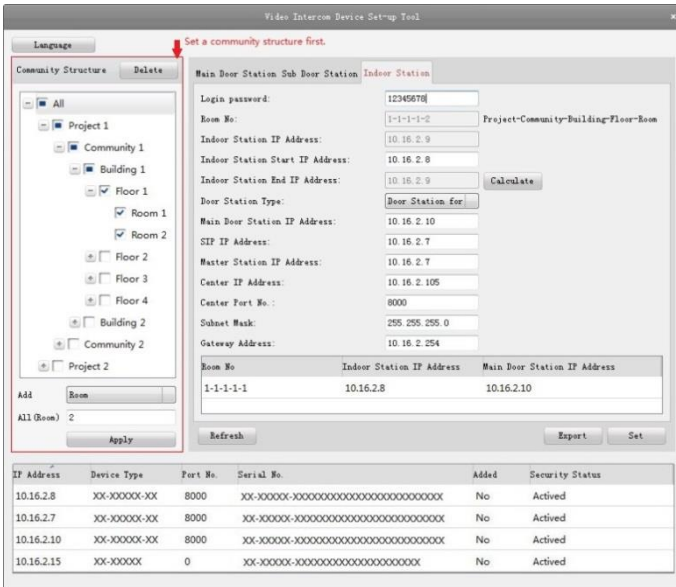

Figure 8-36 Set a Community Structure

### 8.4.2 Setting Main/Sub Door Station

#### Setting a Main Door Station

**Purpose:**

You can activate the online main door station, and configure the building No. for the online main door station.

**Steps:**

1. Select the community, and press the **Main Door Station** tab to switch to the main door station configuration interface.

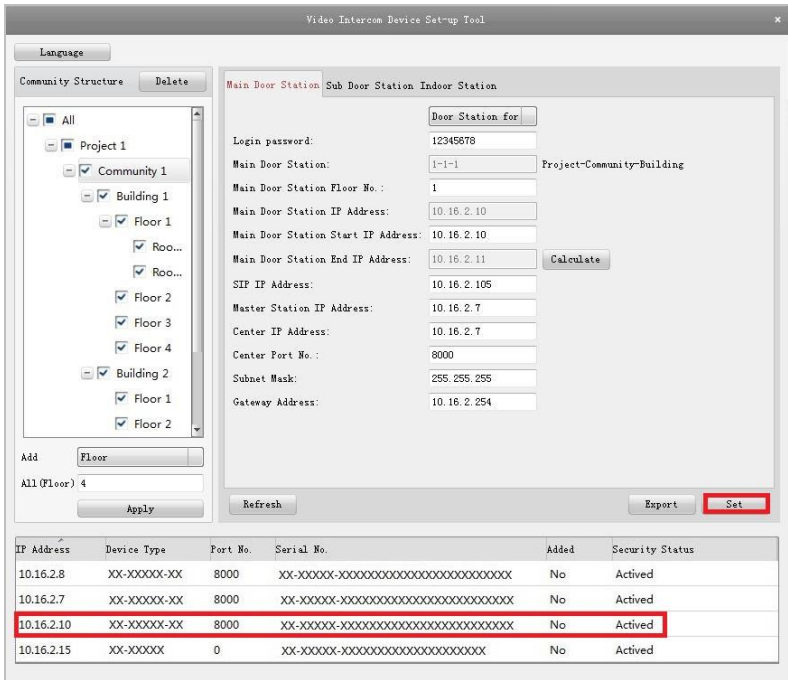

Figure 8-37 Set a Main Door Station

2. Select the door station type from the drop-down list menu: Door Station for Unit, or Door Station for Villa.
3. Input the main door station start IP address, set the main door station floor No., and then click **Calculate** to generate the main door station end IP address and main door station No. (like 1-1-1) automatically.
4. Set the linked network parameters for the main door station: SIP IP address, master station IP address, center IP address, center port No., subnet mask, and gateway address.
5. Select an online door station, input the login password, and click **Set**.

**Note:**

- The default main door station floor No. is 1.
- For the login password, if the main door station has been activated, input the activation password here. If the main door station is not activated, create a login password here, and the main door station will be activated simultaneously.
- When the device is successfully configured, it prompts the note: Configuring main door station parameters succeeded.

## Setting Sub Door Stations

### Steps:

1. Select the community, and press the **Sub Door Station** tab to switch to the sub door station configuration interface.

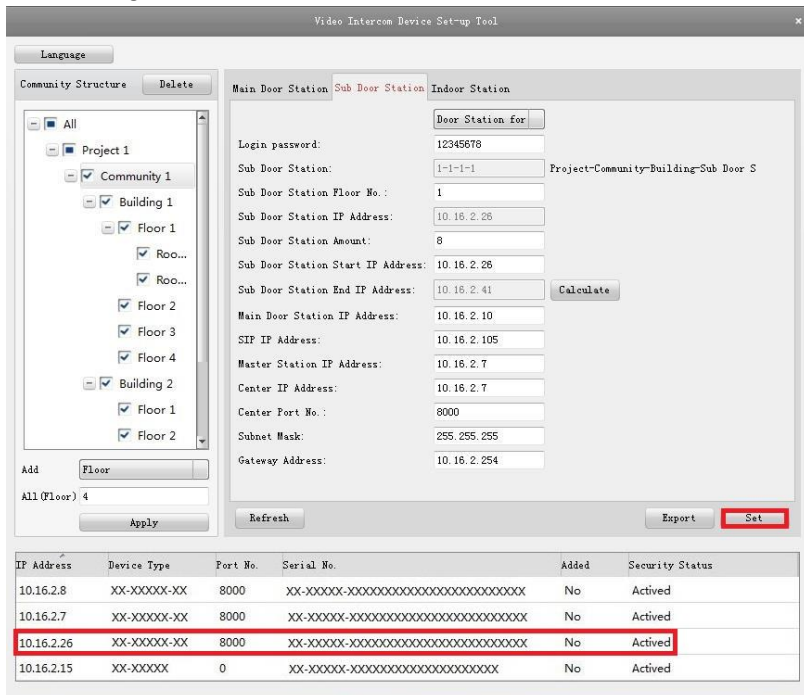

Figure 8-38 Set Sub Door Stations

2. Select the door station type from the drop-down list menu: Door Station for Unit, or Door Station for Villa.
3. Set the sub door station parameters (sub door station amount, floor No., start IP address, end IP address), and then click **Calculate** to generate the sub door station end IP address and sub door station No. (like 1-1-1-1) automatically.
4. Set the linked network parameters for the sub door station: main door station IP address, SIP IP address, master station IP address, center IP address, center port No., subnet mask, and gateway address.
5. Select an online door station, input the login password, and click **Set**.

### Note:

- The default sub door station floor No. is 1.
- Up to 8 sub door stations can be added to a main door station.



- For the login password, if the sub door station has been activated, input the activation password here. If the sub door station is not activated, create a login password here, and the sub door station will be activated simultaneously.
- When the device is successfully configured, it prompts the note: Configuring main door station parameters succeeded

## 8.5 Batch Upgrading

In the device list area, click  to enter the batch upgrading interface.

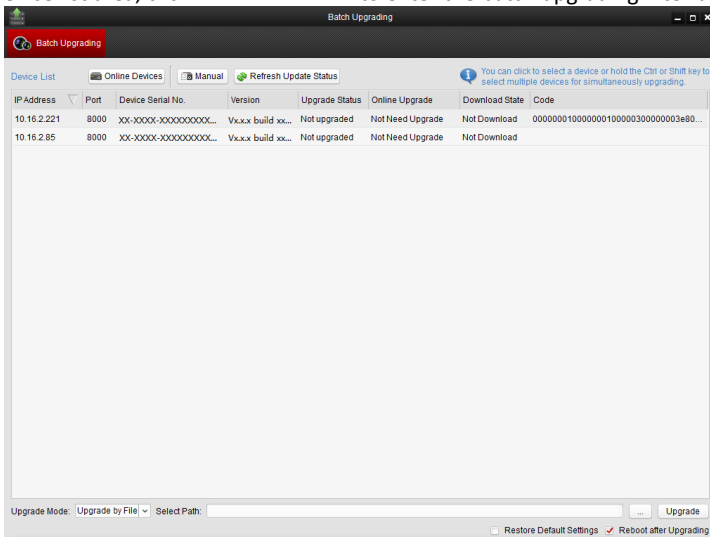

Figure 8-39 Batch Upgrading

### 8.5.1 Adding Devices for Upgrading

You should add the device to the batch upgrading tool first before upgrading the device. There are 2 ways to add the device: adding online device, and adding by IP address/IP segment.

#### Adding Online Device

##### Steps:

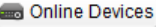
1. In the batch upgrading interface, click the  to open the online device window.

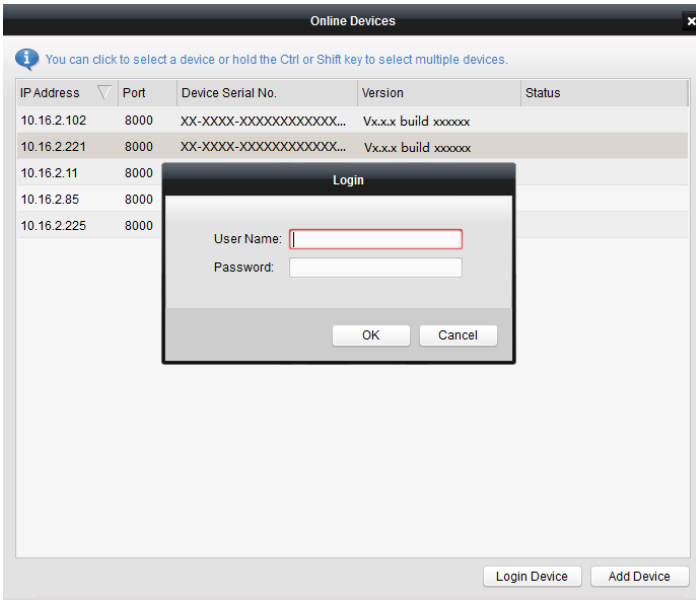

Figure 8-40 Login

2. Select a device, input the user name and password, and click **Login Device**.
3. Click **Add Device**, and the device is added to the batch upgrading tool.

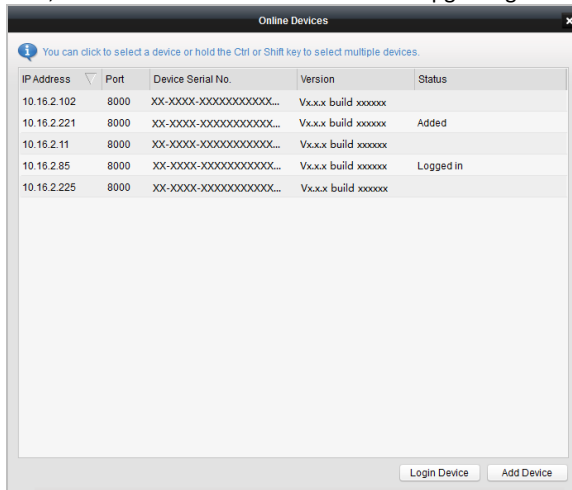

Figure 8-41 Online Devices

## Adding by IP Address/IP Segment

### Steps:

1. Click **Manual** to open the device adding window.
2. Input the corresponding information (IP address, user name, password, start IP address, end IP address).
3. Click **Add**.

The screenshot shows a 'Search' dialog box with two sections for adding devices:

- By IP:** This section contains four input fields: 'IP Address' (empty), 'Port' (8000), 'User Name' (empty), and 'Password' (empty). An 'Add>>' button is located to the right of the 'Password' field.
- By IP Segmen:** This section contains five input fields: 'Start IP' (empty), 'End IP' (empty), 'Port' (8000), 'User Name' (empty), and 'Password' (empty). An 'Add>>' button is located to the right of the 'Password' field.

A 'Cancel' button is located at the bottom right of the dialog box.

Figure 8-42 Adding by IP Address/IP Segment

## 8.5.2 Upgrading Devices

There are 2 upgrading modes available: upgrading by file, and online upgrading.

### Upgrading by File

Upgrading by File: You upgrade the device or devices via the local upgrade files.

#### Steps:

1. Select a device or multiple devices, and select “Upgrade by File” as the upgrading mode.
2. Click  to pop up the window for opening the upgrading file.

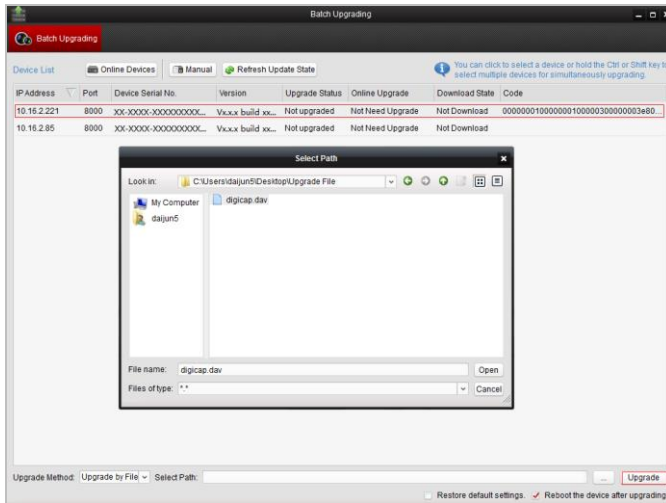

Figure 8-43 Upgrade by File

3. Open the upgrading file, and click **Upgrade**.

### Online Upgrading

Online Upgrading: The batch upgrading tool will search the latest upgrading file for the device automatically. You upgrade the device or devices via the local upgrading files.

#### Steps:

1. Select a device or multiple devices, and select “Online Upgrading” as the upgrading mode.
2. Click **Download**. Click **Upgrade** after the online upgrading file has been wholly downloaded.

## 9 Remote Operation via iVMS-4200 Client Software

The Video Intercom module provides remote control and configuration on video intercom products via the iVMS-4200 client software.

Before remote configure and control the video intercom, you are required to add the device to the software first. Refer to *9.2 Device Management*.

For remote configuration of video intercom device via the iVMS-4200 client software, refer to *9.3 Configuring Devices Remotely via iVMS-4200*.

For the picture storage on storage server, refer to *9.4 Picture Storage*.

For remote control of video intercom devices, please refer to *9.6 Video Intercom Configuration*.



### 9.1 System Configuration

#### **Purpose:**

You can configure the video intercom parameters accordingly.

#### **Steps:**

1. Open the System Configuration page: **Control Panel -> Maintenance and Management -> System Configuration -> Video Intercom**.
2. Click the **Video Intercom** tab to enter the Video Intercom Settings interface.
3. Input the required information.

**Ringtone:** Click the icon  and select the audio file from the local path for the ringtone of indoor station. Optionally, you can click the icon  for a testing of the audio file.

**Max. Ring Duration:** Input the maximum duration of the ringtone, ranging from 15 seconds to 60 seconds.

**Max. Speaking Duration with Indoor Station:** Input the maximum duration of speaking with the indoor station, ranging from 120 seconds to 600 seconds.

**Max. Speaking Duration with Door Station:** Input the maximum duration of speaking with the door station, ranging from 90 seconds to 120 seconds.

**Card Reader Type:** Select the card reader to issue cards.

4. Click **Save** to save the settings.

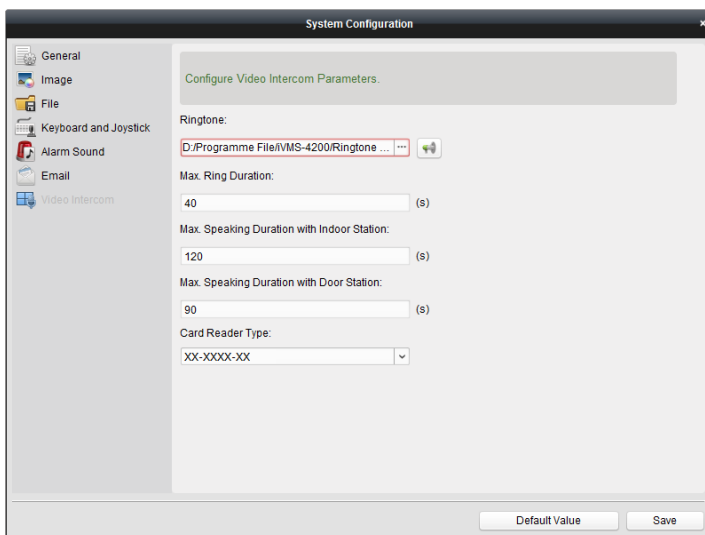

Figure 9-1 System Configuration Interface

## 9.2 Device Management

### **Purpose:**

Device management includes device activation, adding device, editing device, and deleting device, and so on.

After running the iVMS-4200 client software, video intercom devices should be added to the client software for remote configuration and management.

### 9.2.1 Adding Video Intercom Devices

You can add at most 512 indoor stations and master stations in total to the iVMS-4200, and add at most 16 door stations to the iVMS-4200.

For video intercom devices, you are required to create the password to activate them before they can be added to the software and work properly. For device activation via creating password, please refer *User Manual of iVMS-4200 (Video Intercom) V2.4.2* in the disk for detail steps.

You can add online video intercom devices, and add them manually. Here take adding online video intercom devices as example. For adding video intercom devices manually, please refer *User Manual of iVMS-4200 (Video Intercom) V2.4.2* in the disk for detail steps.

### **Steps:**



1. Click the icon on the control panel, or click **Tools->Device Management** to open the Device Management page.
2. Click the **Server** tab.

**To add indoor station or master station:**

- 1) Click **Add New Device Type** to enter add new device type interface.  
Select **Indoor Station/Master Station** and click **OK**.

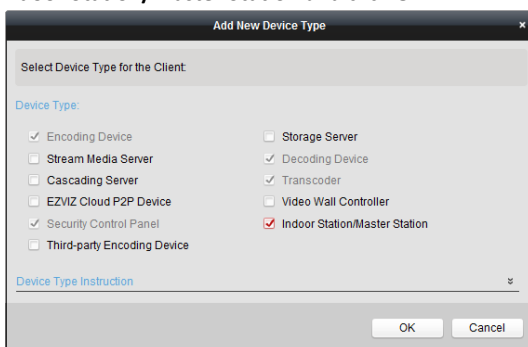

Figure 9-2 Adding New Device Type

- 2) In the Server tab, Video Intercom Device will display, select **Video Intercom Device** and add indoor station and master station.

**To add door station:**

In the Server tab, select **Encoding Device/Outdoor Device** and add door station.

3. The active online devices in the same local subnet with the client software will be displayed on the **Online Device** area. You can click the **Refresh Every 60s** button to refresh the information of the online devices.

Online Device (5)							
Refresh Every 60s							
<span style="color: green;">+</span> Add to Client <span style="color: green;">+</span> Add All <span style="color: blue;">🔗</span> Modify Netinfo <span style="color: blue;">↺</span> Reset Password <span style="color: grey;">💡</span> Activate                        Filter							
IP	Device Type	Firmware Version	Security	Server Port	Start Time	Added	
10.16.2.11	XX-XXXX-XX	Vx.x.x build xxxxxx	Active	8000	2016-07-05 09:21:55	No	
10.16.2.85	XX-XXXX-XX	Vx.x.x build xxxxxx	Active	8000	2019-01-21 21:43:24	Yes	
10.16.2.102	XX-XXXX-XX	Vx.x.x build xxxxxx	Active	8000	2016-07-05 09:33:52	No	

Figure 9-1 Online Device

**Note:** To add online devices to the software, you are required to change the device IP address to the same subnet with your computer first.

4. Select the devices to be added from the list.
5. Click **Add to Client** to open the device adding dialog box.

6. Input the required information.

**Nickname:** Edit a name for the device as you want.

**Address:** Input the device's IP address. The IP address of the device is obtained automatically in this adding mode.

**Port:** Input the device port No.. The default value is 8000.

**User Name:** Input the device user name. By default, the user name is admin.

**Password:** Input the device password. By default, the password is **12345**.

7. Optionally, you can check the checkbox **Export to Group** to create a group by the device name. All the channels of the device will be imported to the corresponding group by default.

**Note:** iVMS-4200 also provides a method to add the offline devices. Check the checkbox **Add Offline Device**, input the required information and the device channel number and alarm input number, and then click **Add**. When the offline device comes online, the software will connect it automatically.

8. Click **Add** to add the device.

The screenshot shows a dialog box titled "Add" with a close button (X) in the top right corner. The dialog is divided into sections. The first section is "Adding Mode:" with five radio buttons: "IP/Domain" (selected), "IP Segment", "IP Server", "HIDDNS", and "Batch Import". Below this is a checkbox labeled "Add Offline Device" which is unchecked. There are several input fields: "Nickname" (containing "Door Station"), "Address" (containing "10.16.1.24"), "Port" (containing "8000"), "User Name" (containing "admin"), and "Password" (containing six dots). There is a checked checkbox for "Export to Group". Below the checkbox is a note: "Set the device name as the group name and add all the channels connected to the device to the group." At the bottom right, there are two buttons: "Add" and "Cancel".

Figure 9-2 Adding Device by IP/Domain

**Note:**

### Add Multiple Online Devices

If you want to add multiple online devices to the client software, click and hold Ctrl key to select multiple devices, and click **Add to Client** to open the device adding dialog box. In the pop-up message box, input the user name and password for the devices to be added.

### Add All the Online Devices



If you want to add all the online devices to the client software, click **Add All** and click **OK** in the pop-up message box. Then input the user name and password for the devices to be added.

### 9.2.2 Modifying Network Information

Select the device from the online list, click **Modify Netinfo**, and then you can modify the network information of the selected device.

The screenshot shows a dialog box titled "Modify Network Parameter". It is divided into two main sections: "Device Information" and "Network Information".

**Device Information:**

- MAC Address: 44-19-b6-5e-fb-4a (with a Copy button)
- Software Version: V5.3.0build 150513 (with a Copy button)
- Device Serial No.: DS-2CD2312-I20140806CCCH475372976 (with a Copy button)

**Network Information:**

- DHCP
- Port: 8000
- IPv4(Don't Save)
- IP Address: 10.16.2.225
- Subnet Mask: 255.255.255.0
- Gateway: 10.16.2.254
- IPv6(Don't Save)
- Password: (empty field)

At the bottom of the dialog are "OK" and "Cancel" buttons.

Figure 9-3 Modify Network Parameter

**Note:**

You should input the admin password of the device in the **Password** field of the pop-up window to modify the parameters.

### 9.2.3 Resetting Password

According to the different video intercom devices, the software provides two different methods for restoring the default password or resetting the password.

Select the device from the online device list, click **Reset Password**.

**Option 1:**

If the window with import file button, key importing mode drop-down list, password and confirm password field pops up, follow the steps below to reset the password:

**Note:**

This option is available to door stations.

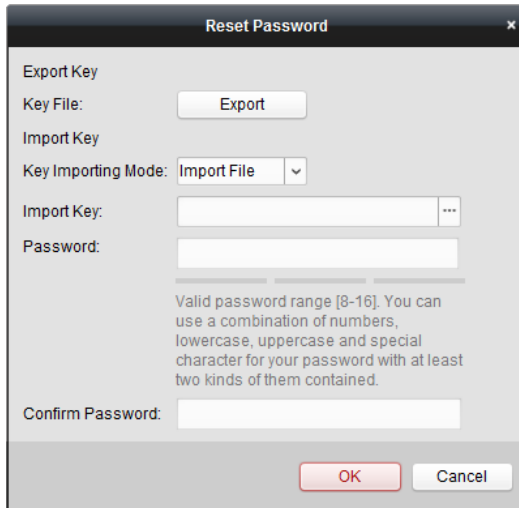



Figure 9-4 Reset Password (Option 1)

1. Click **Export** to save the device file on your computer.
2. Send the file to our technical engineers.
3. Our technical engineer will send you a file to you. After receiving a file from the technical engineer, select **Import File** from Key Importing Mode drop-down list and click  to import the file.
4. Input new password in text fields of **Password** and **Confirm Password**.
5. Click **OK** to reset the password.

**STRONG PASSWORD RECOMMENDED**– *We highly recommend you create a strong password of your own choosing (Using a minimum of 8 characters, including at least three of the following categories: upper case letters, lower case letters, numbers, and special characters.) in order to increase the security of your product. And we recommend you reset your password regularly, especially in the high security system, resetting the password monthly or weekly can better protect your product.*



**Option 2:**

If the window with import file and export file buttons, password and confirm password field pops up, follow the steps below to reset the password:

**Note:** This option is available to indoor stations and master stations.

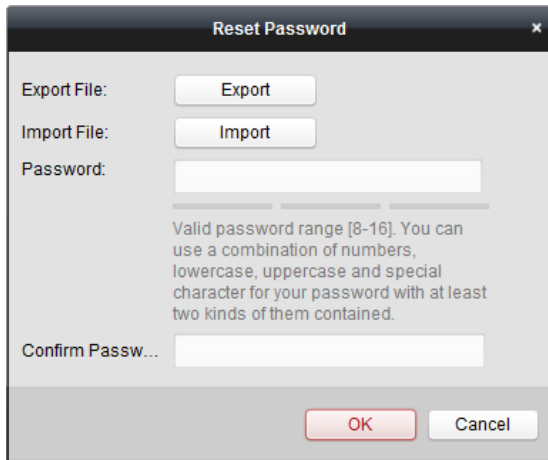

Figure 9-5 Reset Password (Option 2)

1. Click **Export** to save the device file on your computer.
2. Send the file to our technical engineers.
3. Click **Import** and select the file received from the technical engineer.
4. Input new password in text fields of **Password** and **Confirm Password**.
5. Click **OK** to reset the password.

**STRONG PASSWORD RECOMMENDED**–



*We highly recommend you create a strong password of your own choosing (Using a minimum of 8 characters, including at least three of the following categories: upper case letters, lower case letters, numbers, and special characters.) in order to increase the security of your product. And we recommend you reset your password regularly, especially in the high security system, resetting the password monthly or weekly can better protect your product.*

## 9.3 Configuring Devices Remotely via iVMS-4200

Configuring devices remotely via iVMS-4200 is the same with that via Batch Configuration Tool, please refer 8.3 *Configuring Devices Remotely* for detail steps.

## 9.4 Picture Storage

When the video intercom device is under armed status, it will capture the picture automatically after unlocking the door. The captured picture can be uploaded and stored in the storage server.

When starting the live view of door station via iVMS-4200, you can capture the live view picture. The captured picture can be uploaded and stored in the storage server.

**Note:**

- This function is only available to door stations.
- You are required to add storage server to the iVMS-4200, and format the HDDs first before uploading and storing captured pictures.

### 9.4.1 Adding Storage Server

**Before you start:**

The storage server application software needs to be installed and it is packed in the iVMS-4200 software package. When installing the iVMS-4200, check the checkbox of **Storage Server** to enable the installation of storage server.

1. Click the icon  on the desktop to run the storage server.
2. Open the Device Management page and click the **Server** tab.
3. Click **Add New Device Type**, select **Storage Server** and click **OK**.

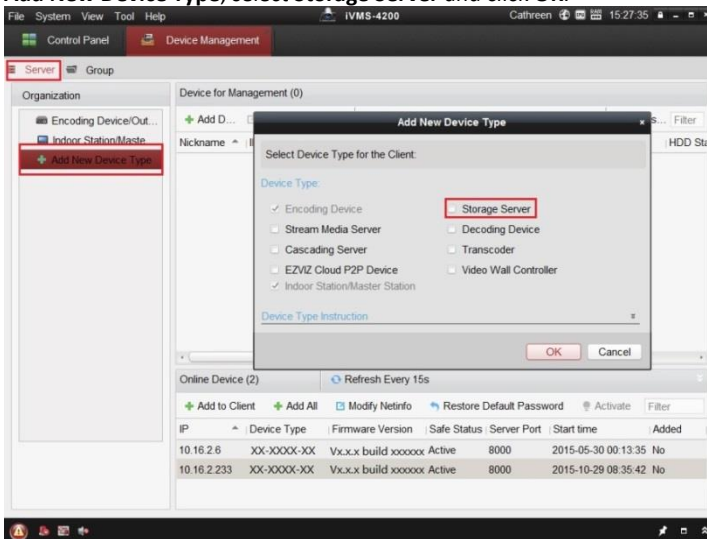

Figure 9-6 Adding Storage Server Type

4. Click **Storage Server** on the list to enter the Storage Server Adding interface.

**Note:** For adding the storage server, please refer to *User Manual of iVMS-4200 (Video Intercom) V2.4.2* in the disk.

## 9.4.2 Formatting the HDDs

The HDDs of the storage server need to be formatted for the captured picture storage.

### Steps:

1. Select the added storage server from the list and click **Remote Config**.
2. Click **Storage->General** to enter the HDD Formatting interface.
3. Select the HDD from the list and click **Format**. You can check the formatting process from the process bar and the status of the formatted HDD changes from *Unformatted* to *Normal Status*.

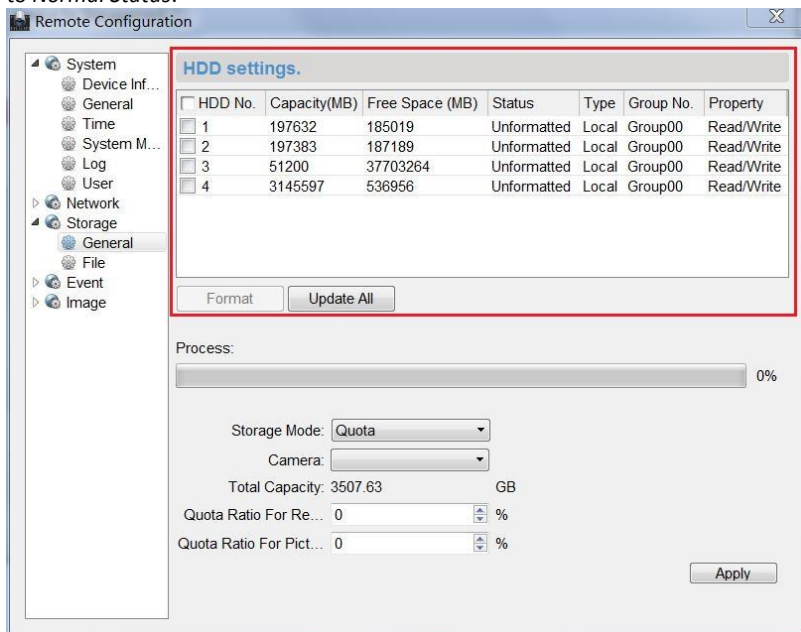

Figure 9-7 Format HDDs

**Note:** Formatting the HDDs is to pre-allocate the disk space for storage and the original data of the formatted HDDs will be deleted.

## 9.4.3 Configuring Storage Server Picture Storage

### Before you start:

The storage server needs to be added to the client software and the HDDs need to be formatted for the captured pictures storage.

### Steps:

1. Open the Record Schedule page.
2. Select the camera from the Camera Group list.
3. Select the storage server from the **Storage Server** drop-down list.  
**Note:** You can click **Storage Server Management** to add, edit or delete the storage server.
4. Check the checkbox of **Picture Storage** to store the alarm pictures of the camera when event occurs.

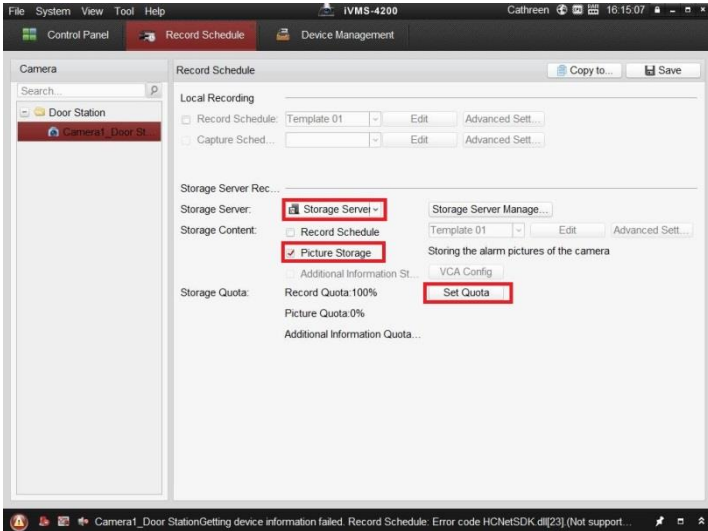

Figure 9-8 Setting Storage Server

5. Click **Set Quota** to enter the HDD management interface of the storage server. You can set the corresponding quota ratio for captured picture information.

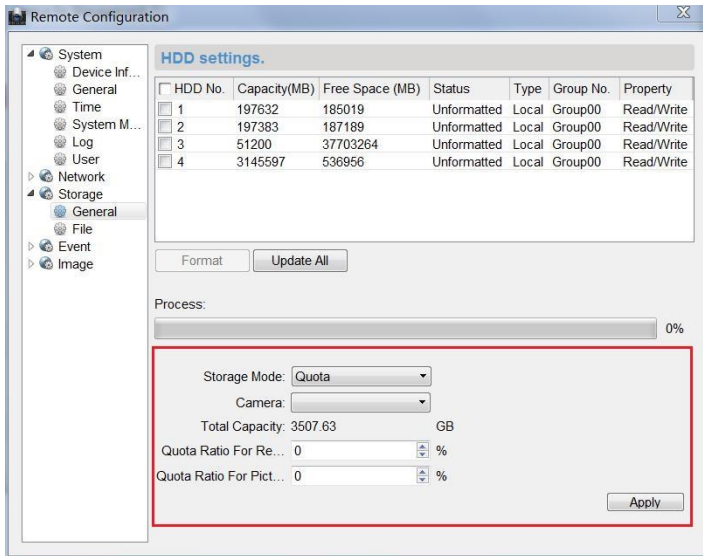

Figure 9-9 Setting Quota

**Example:** If you set the picture quota as 60%, then the 60% of the storage space can be used for storing the captured pictures.

6. Click **Save** to save the settings.

## 9.5 Live View

### **Purpose:**

The live view page allows you to view the real-time video, capture images, and unlock the door.

### **Steps:**

1. Enter the main view interface of iVMS-4200 client software to display the live view of door station.

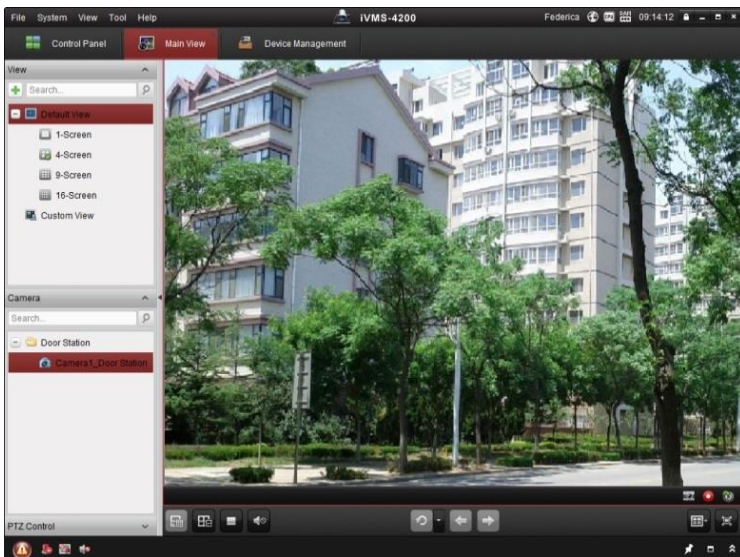

Figure 9-3 Live View of Door Station

2. Right click on the live view interface to display the menu and select **Unlock** to remote unlock the door.

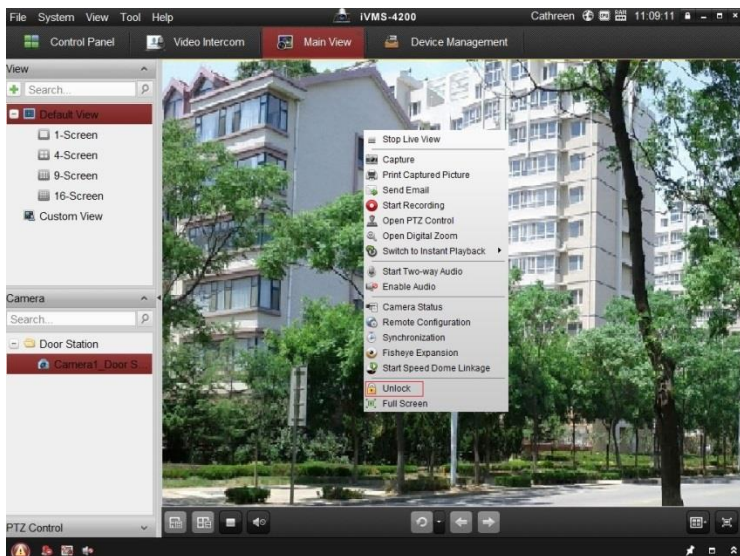

Figure 9-4 Menu of Live View Interface



## 9.6 Video Intercom Configuration



Click the icon on the control panel of iVMS-4200 or click **View -> Video Intercom** to open the Video Intercom page. On the Video Intercom page, you can control video intercom devices remotely. There are 4 modules on the Video Intercom page:

**Video Intercom:** Start visual communication with door stations, and manage incoming calls from indoor stations and door stations and master stations. Refer 9.6.2 *Video Intercom* for detail steps.

**Group Management:** Construct virtual communities according to the real community situations, and assign door stations and indoor stations to the community accordingly. Refer 9.6.1 *Group Management* for detail steps.

**Note:** You should manage groups first before starting the visual communication with indoor stations or door stations.

**Card Management:** Add unauthorized cards to the iVMS-4200, and issue card to the door station via the client software.

**Note:** The vandal-resistant door station does not support the card management.

**Notice Management:** Send information to indoor stations, search information, search call logs, and search unlocking logs. Refer 9.6.3 *Notice Management* for detail steps.

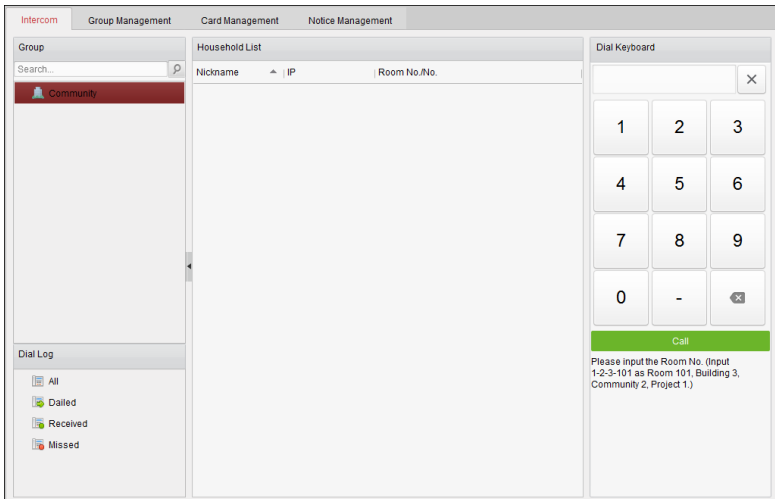

Figure 9-10 Intercom Interface

## 9.6.1 Group Management

### Purpose:

You can add groups to community, outer door station, or other, and assign devices to each group.

Click **Control Panel -> Video Intercom -> Group Management** to add, edit, and delete groups. Three group types can be selected: community, outer door station and other.

### Adding Group

1. Click the **Group Management** tab to enter the group management interface.

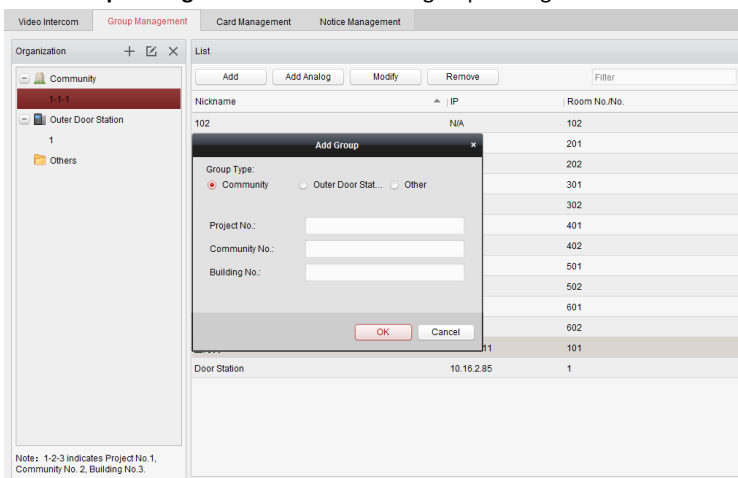

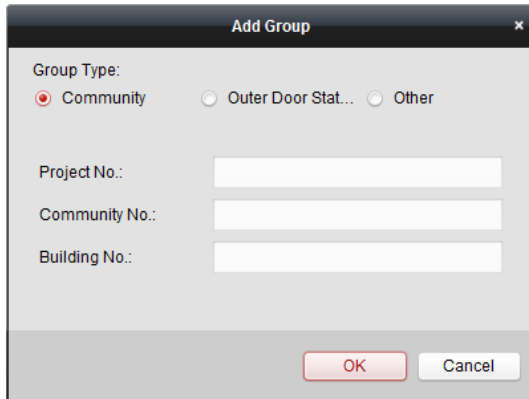

Figure 9-11 Adding Group

2. Click  to pop up group adding window, and input the corresponding information accordingly.

- Select **Community** as group type, and then Input the Community No., building No., and Unit No. to set the community structure, as shown in the figure below.



The screenshot shows a dialog box titled "Add Group" with a close button (X) in the top right corner. Under "Group Type:", the "Community" radio button is selected. Below this are three text input fields labeled "Project No.:", "Community No.:", and "Building No.:". At the bottom right, there are two buttons: "OK" and "Cancel".

Figure 9-12 Adding Community

- Select **Outer Door Station** as group type, and then input the outer door station No. (Range: 1 to 9) to set the outer door station, as shown in the figure below.

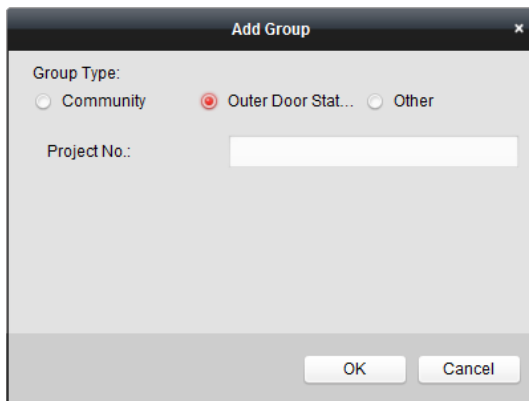

The screenshot shows the same "Add Group" dialog box. In this instance, the "Outer Door Stat..." radio button is selected. The "Project No.:" text input field is present, but the "Community No.:" and "Building No.:" fields are not visible. The "OK" and "Cancel" buttons are at the bottom right.

Figure 9-13 Adding Outer Door Station

- Select **Other** as group type, and then input the group name.

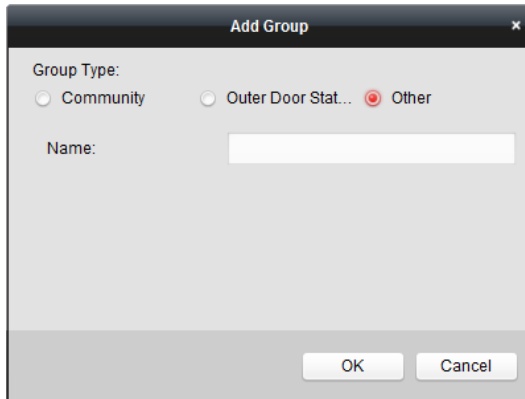

Figure 9-14 Adding Other

**For example:** You can name the group as administrator, entrance guard and cleaning staff, etc.

**Note:** When selecting **Other** as the group type, you can set different groups for staff other than residents, such as administrator, security guard and cleaning staff, etc., and you can assign cards to these staff and configure different permissions to them.

3. Click **OK** to complete group adding.

### Assigning IP Devices to Group

After adding groups to Community, Outer Door Station, or Other, you should assign devices to the group.

**For example:** You should assign indoor stations and door stations to the group 1-1-1 in Community.

1. Click **Add** to enter the Add Resident Interface and the video intercom devices added to the client software will be listed, as shown in the figure below.

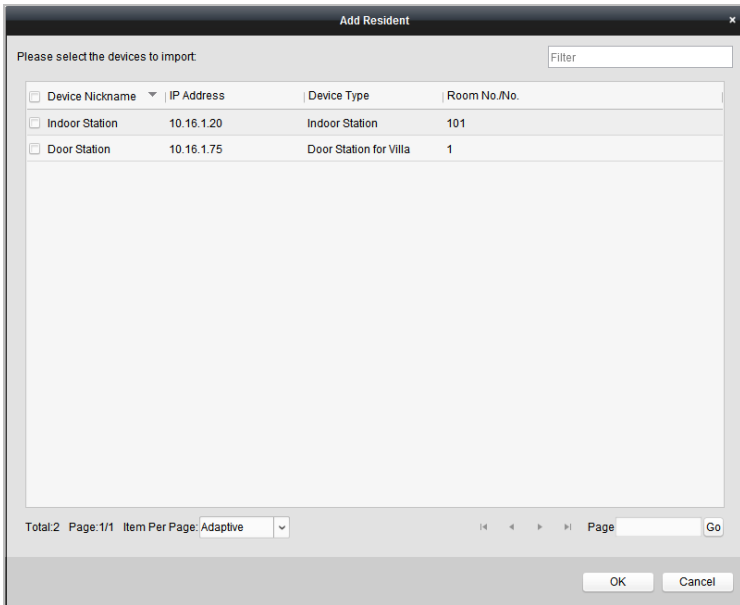

Figure 9-15 Adding Resident

2. Check the checkbox of device.

**Indoor Station:** set a Room No. for the indoor station.

**Door Station:** set a No. for the door station.

3. Click **OK** to save the settings.

### Assigning Analog Devices to Group

When assigning analog devices to group, only analog indoor stations are supported.

1. Click **Add Analog** to pop up analog device adding window. You can add analog devices singly or in batch.
  - Adding Devices in Batch: Input the start floor and end floor, and set the room numbers.

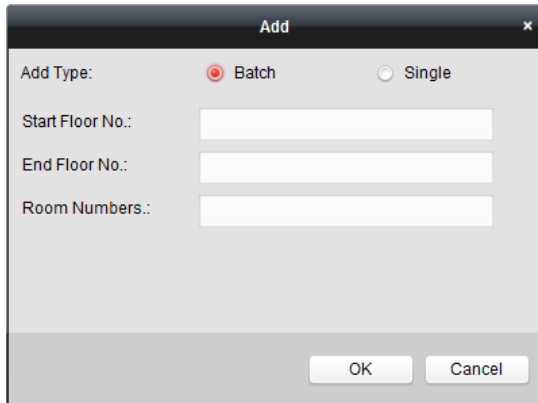

Figure 9-16 Adding Devices in Batch

**Note:** Room Numbers here refers to the room numbers in each floor.

- Adding Devices Singly: Input the room No..

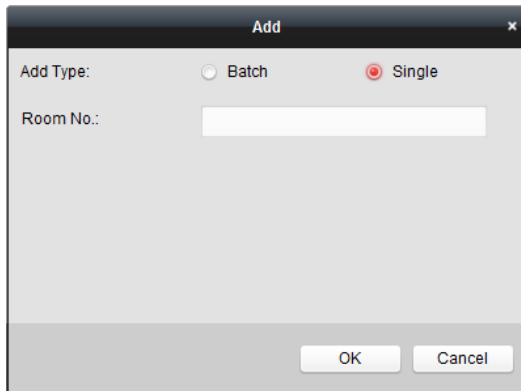

Figure 9-17 Adding Device Singly

**Note:** The room No. format is like 101.

2. Click **OK** to save the settings.

### Modifying Device Information

1. Select an added device.
2. Click **Modify** to enter the device modifying interface.

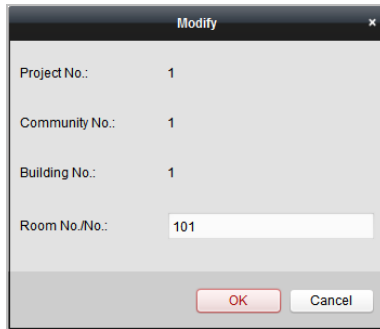

Figure 9-18 Modifying Device Information

3. Click **OK** to complete the device modifying operation.

### Deleting Device

1. Select an added device.
2. Click **Remove** to pop up a dialog box.

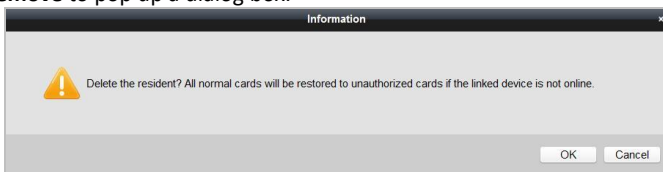

Figure 9-19 Information

3. Click **OK** to complete the group deleting operation.

## 9.6.2 Video Intercom

### Receiving Call from Door Station

#### **Purpose:**

When the door station has been added to the client software, you can call iVMS-4200 via door station.

#### **Before you start:**

- Make sure the door station has been added to the iVMS-4200 client software.
- Make sure the SIP server IP address of the door station is not configured (or abnormal).

#### **Steps:**

Press **Calling Center** key on the door station.

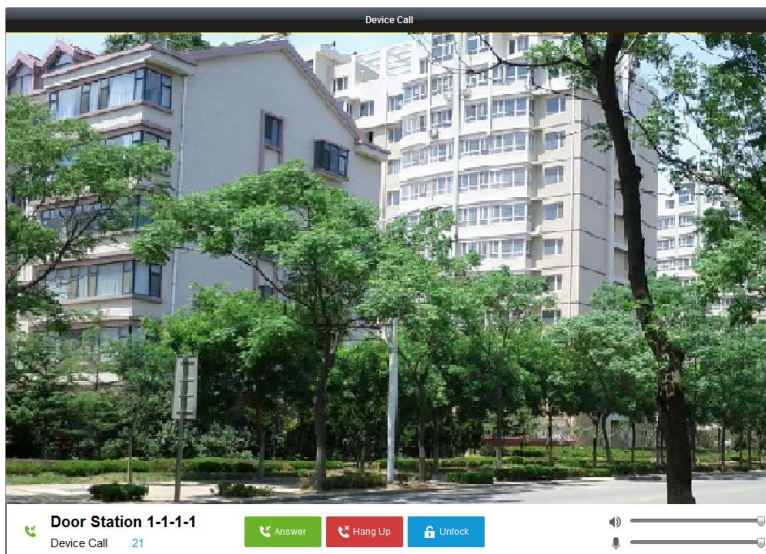

Figure 9-20 Calling from Door Station

**Note:**

- When the SIP server IP of the door station is configured, press **Calling Center** key on the door station to call the master station instead of iVMS-4200.
- Click **Unlock** to unlock the building or villa door via iVMS-4200, no matter whether answering the call from door station or not.
- Click **Answer** to answer the call from door station.
- Click **Hang Up** to end the call from door station.

**Call Log**

On the Video Intercom tab page, there are four types of call logs you can search: **All**, **Dialed**, **Received**, and **Missed**.

On the dial log area, you can view detail information of the dialog, and click **Call** to start the audiovisual call with the indoor station.

Click  **Clear Log** to clear all logs in the list (optional).

**9.6.3 Notice Management**

**Querying Call Logs**

**Steps:**

1. Click **Query Call Logs** to enter the call log querying page.



2. Select the calling status, device type, and set the start time and end time, and click **Query** to search the call log.

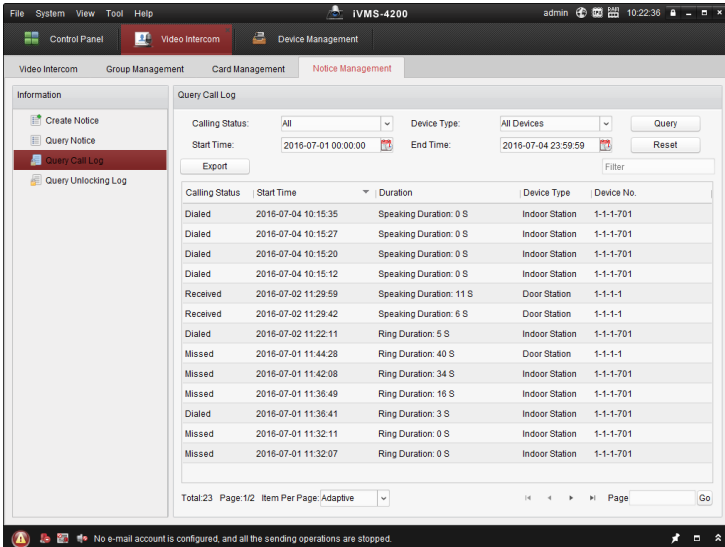

Figure 9-21 Call Log Interface

3. Click **Export** to export the call logs as an excel file.

### Querying Unlocking Log

#### Steps:

1. Click **Query Unlocking Logs** to enter the unlocking log querying page.
2. Select the unlocking type, device type, and set the start time and end time, and click **Query**.

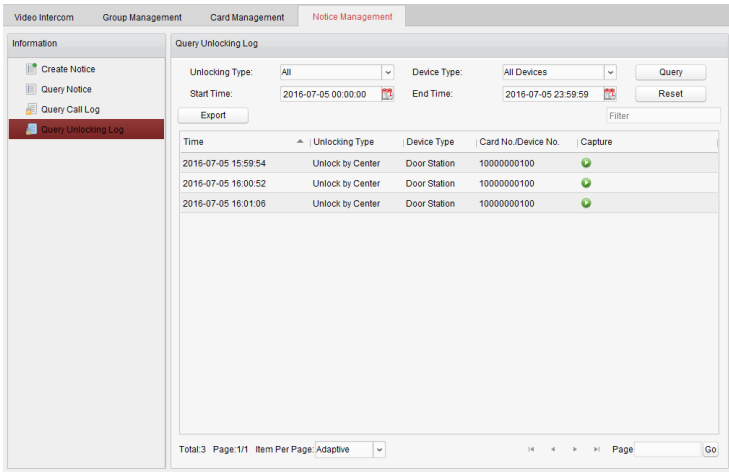

Figure 9-22 Unlocking Log Interface

3. Click **Export** to export the unlocking logs as an excel file.

## 9.7 Device Arming Control

### Steps:

1. Select **Tool->Device Arming Control** to pop up device arming control window.



Figure 9-23 Tool Bar

2. Set the arming status of the device as armed, and the alarm information will be auto uploaded to the client software when alarm occurs.

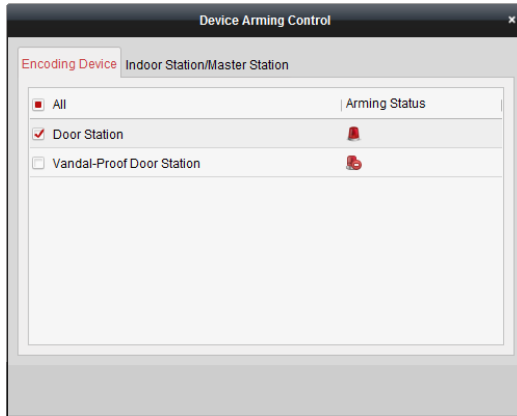

Figure 9-24 Device Arming Control

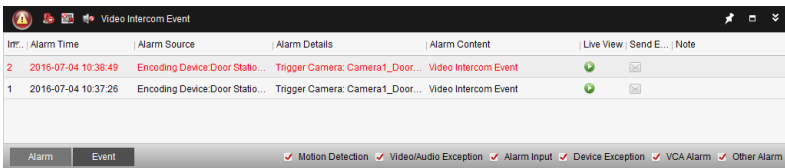

Figure 9-25 Alarm Events

**Note:** After adding the device to the client software, it will be armed automatically.

## Appendix

### Installation Notice

While installing the door station, please make sure that the distance between any two devices is far as possible to avoid the howling and echo. The distance between two devices is recommended to be longer than 10 meters.



Devices here refer to indoor station, door station, doorphone and master station.

### Wiring Cables

Cable	Specification
Power Cord of Door Station	RVV 2*1.0
Network Cable of Door Station	UTP-five Categories
Door Lock Wiring (With Door Magnetic)	RVV 4*1.0
Door Lock Wiring (Without Door Magnetic)	RVV 2*1.0
Exit Button Wiring	RVV 2*0.5



First Choice for Security Professionals